

# ALESSIO AE 13

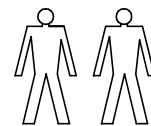

P

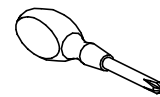
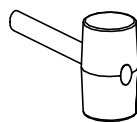
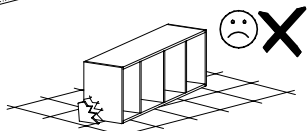
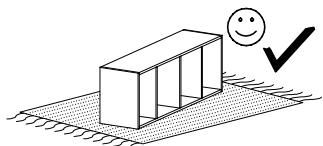
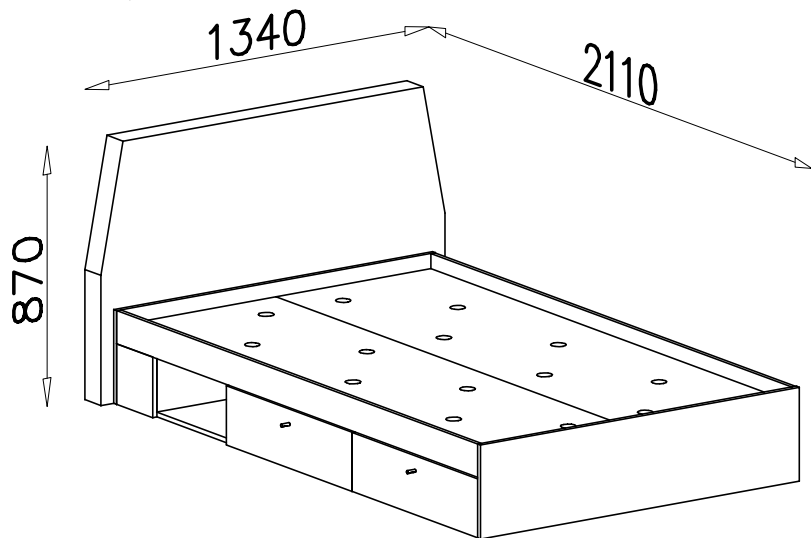

L

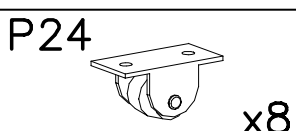
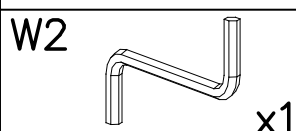
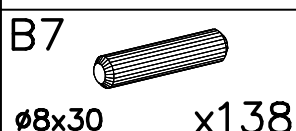
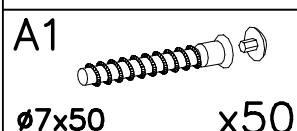
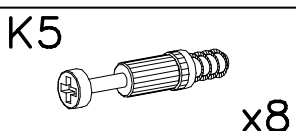
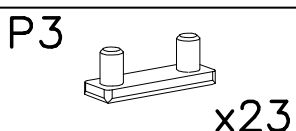
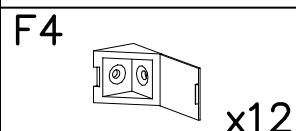
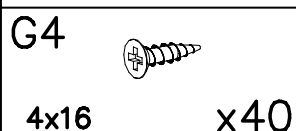
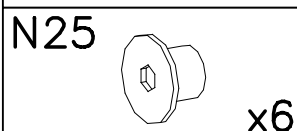
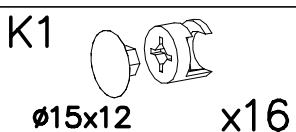
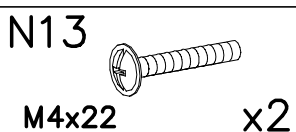
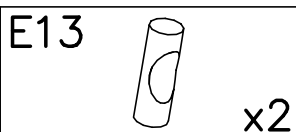
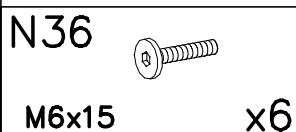
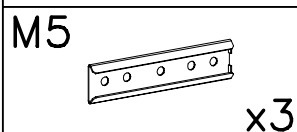
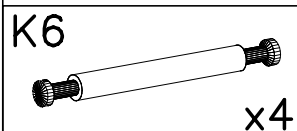
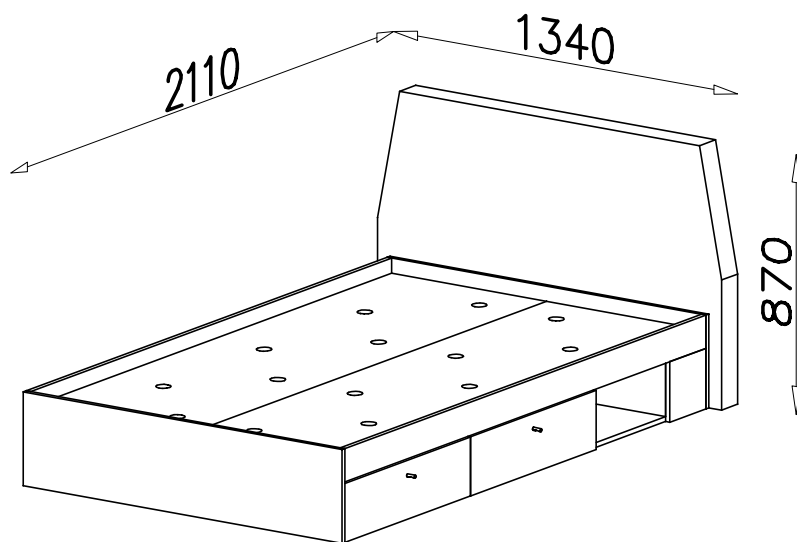

I

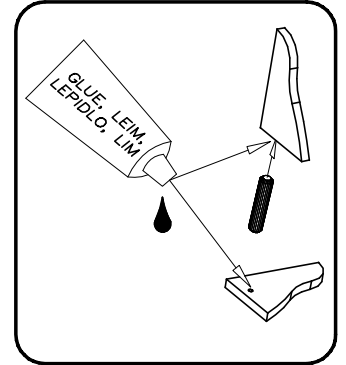
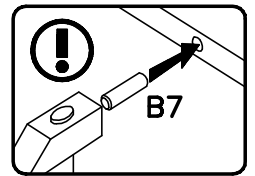
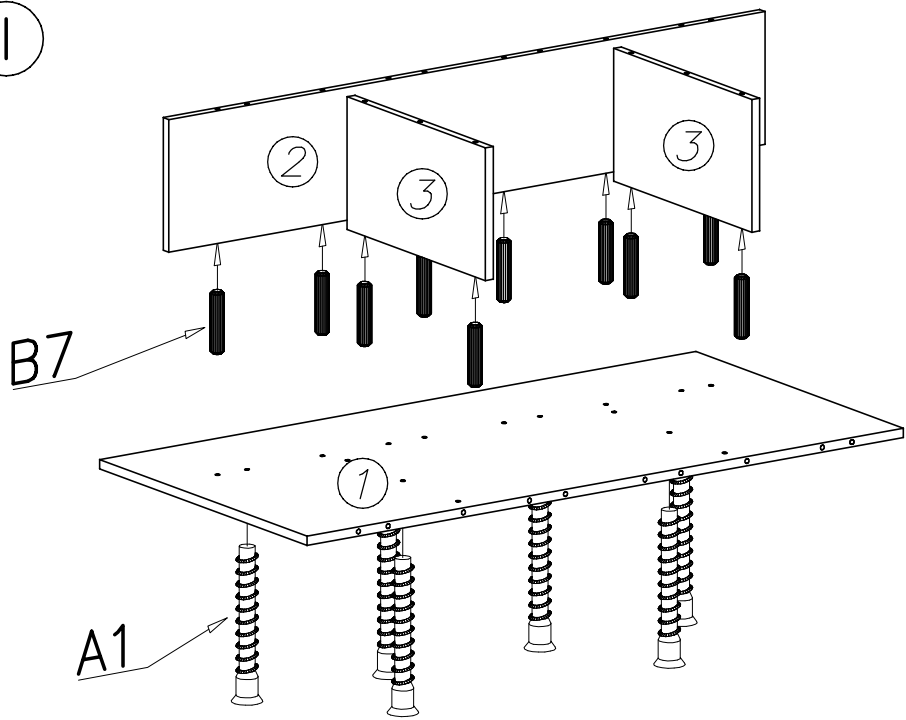

II

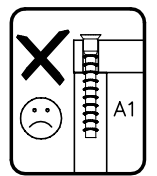
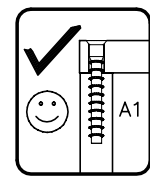
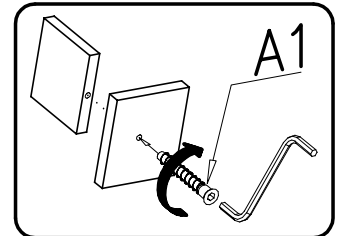
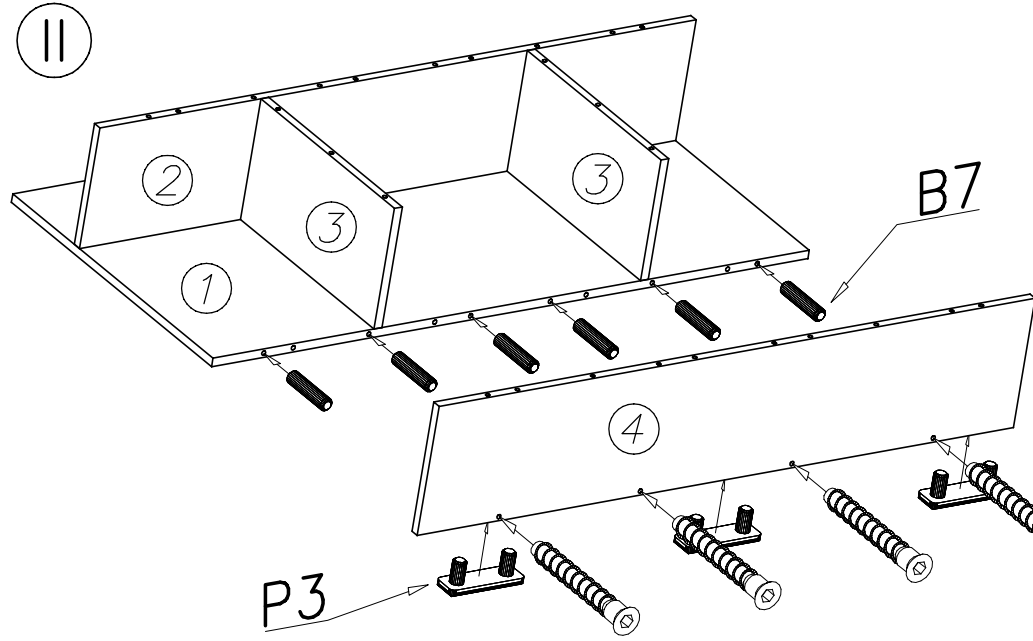

III

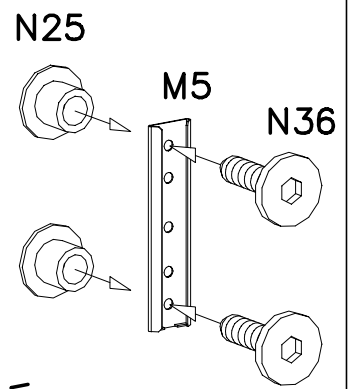
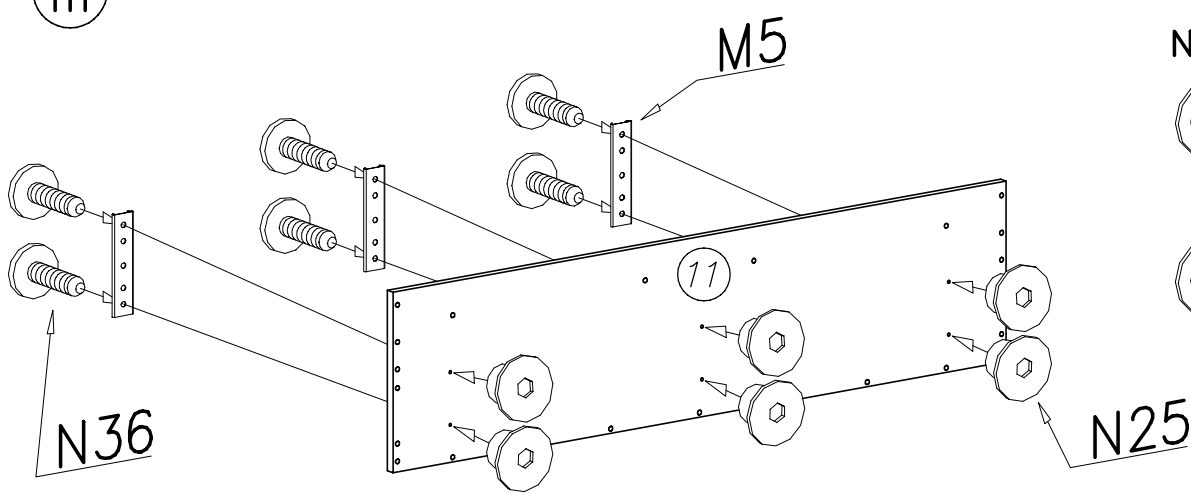

IV

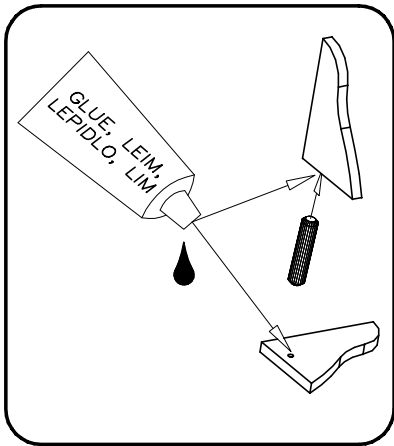
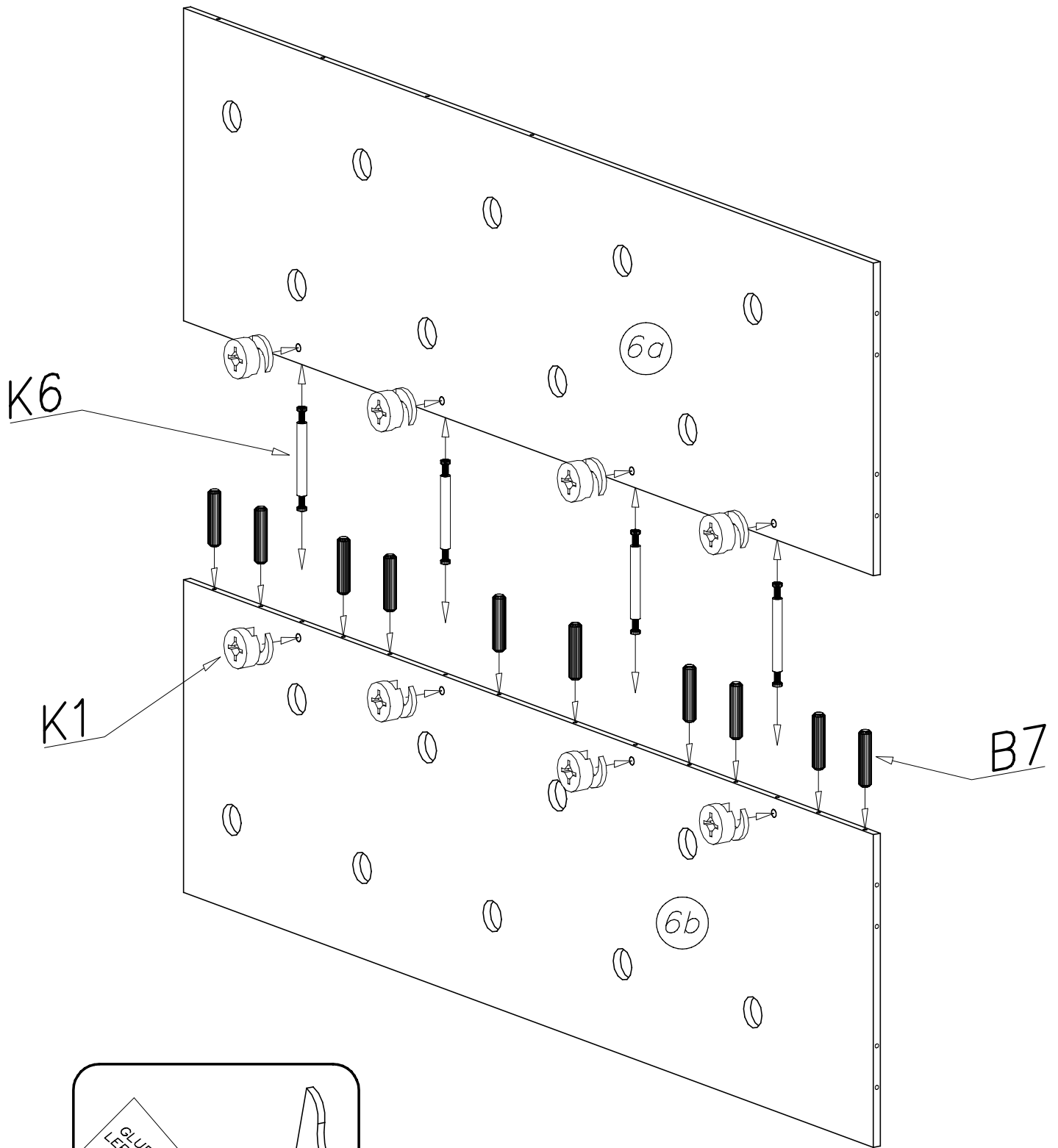

V

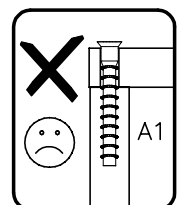
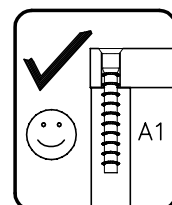
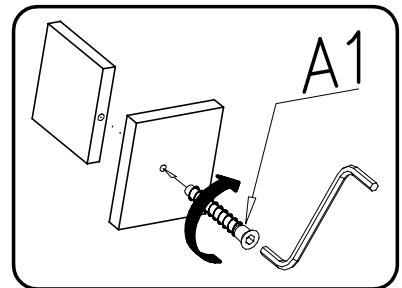
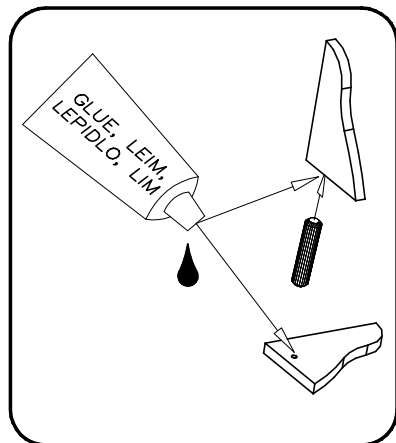
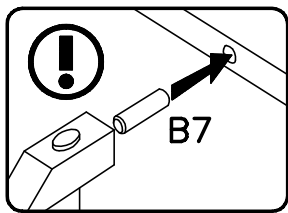
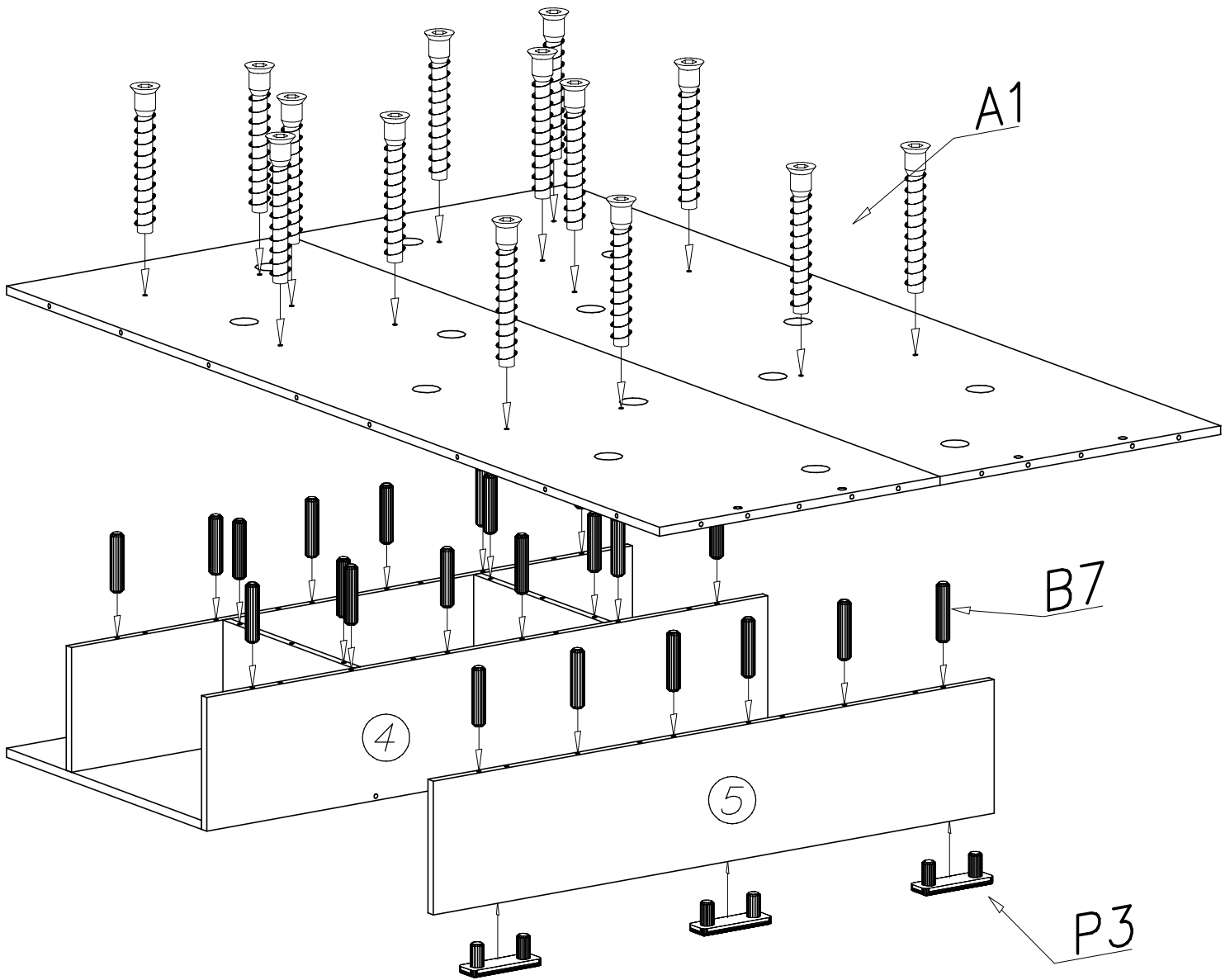

VI

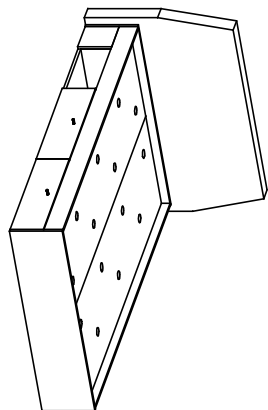

P

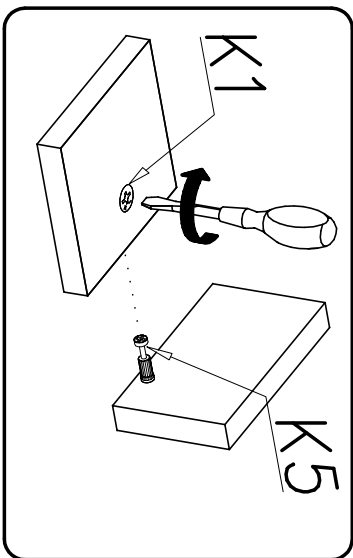
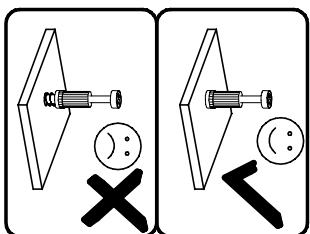
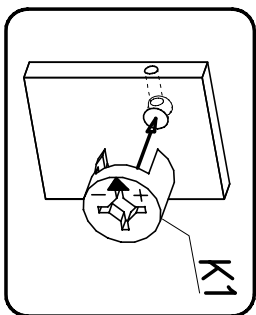
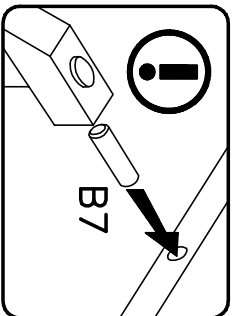
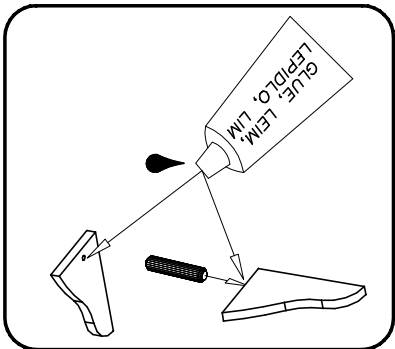
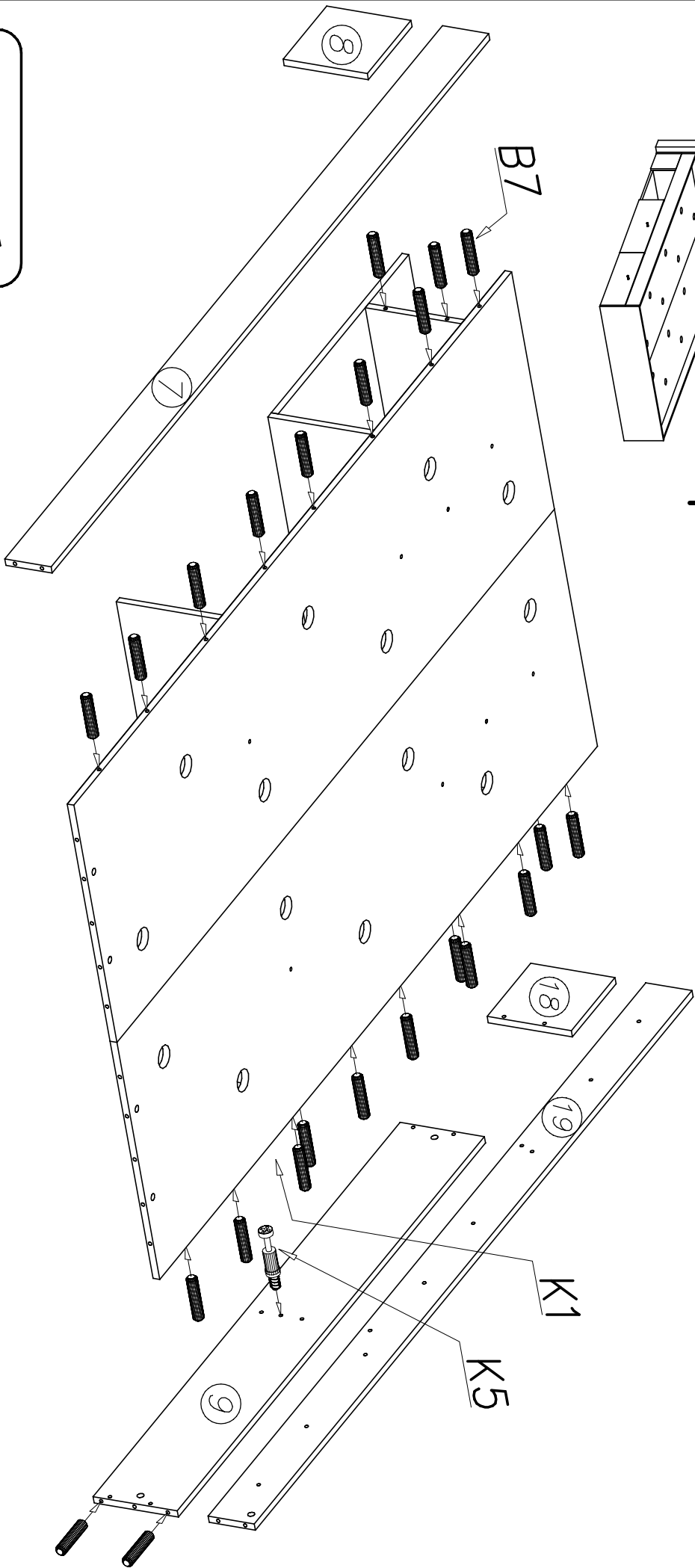

VI

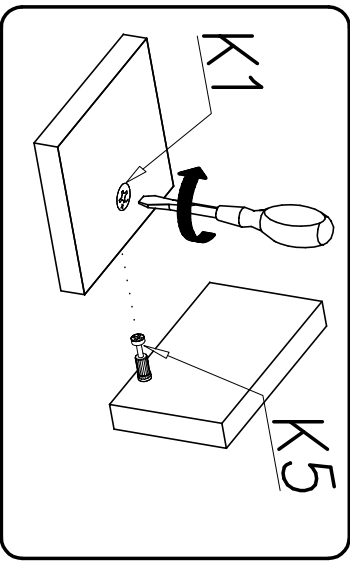
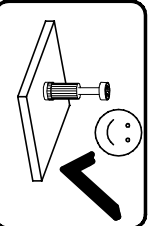
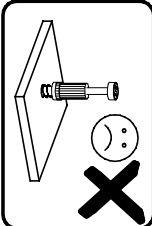
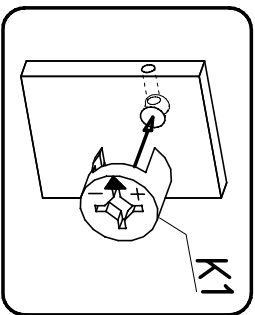
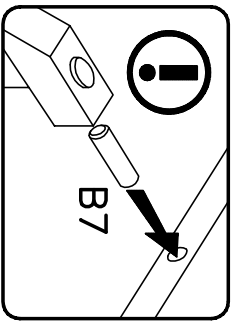
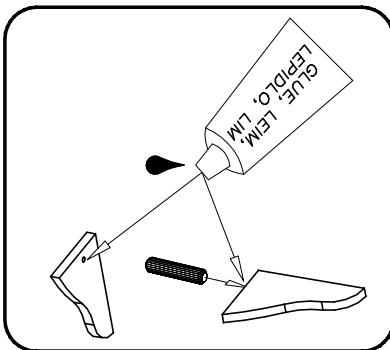
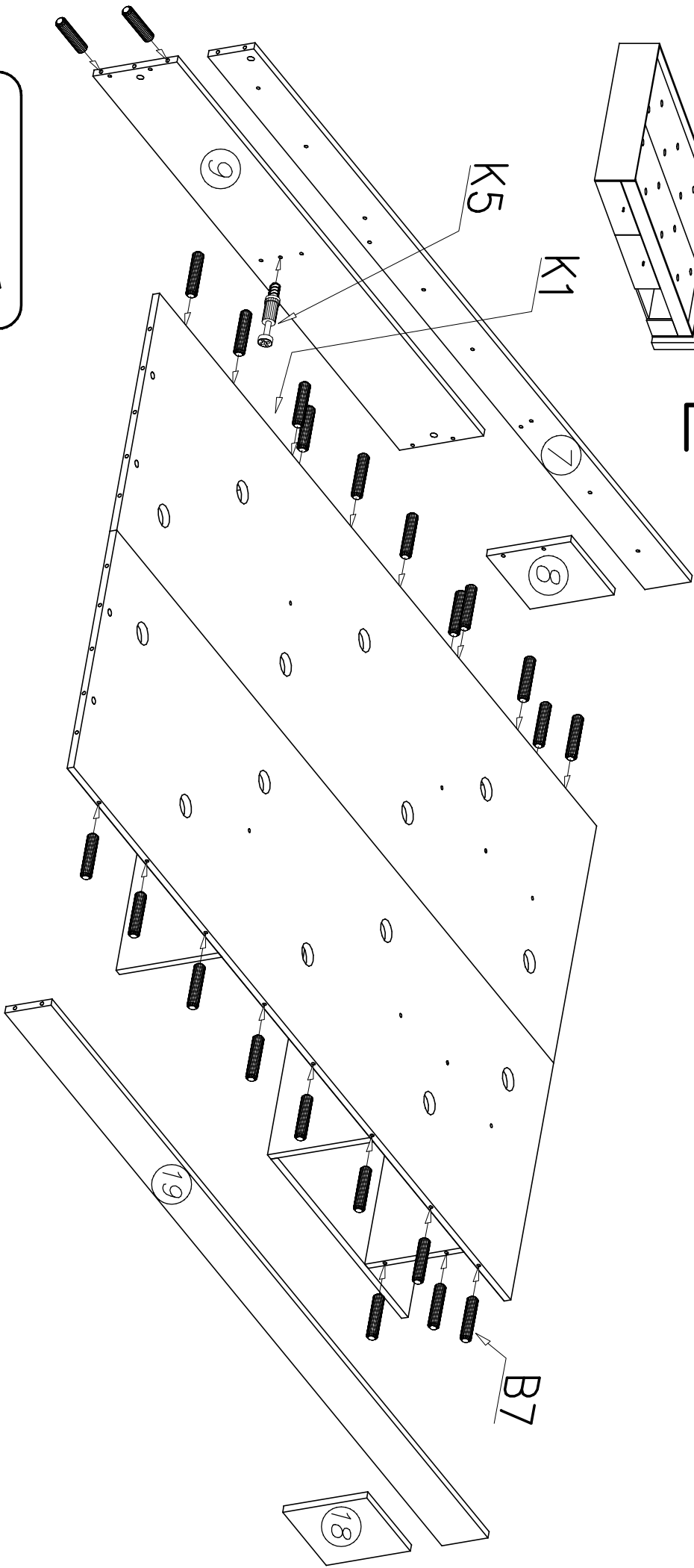
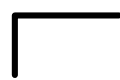
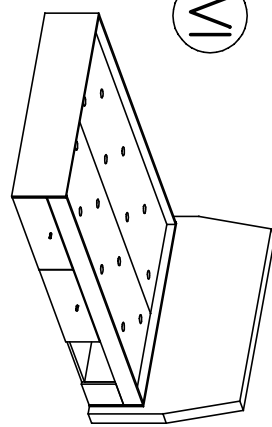

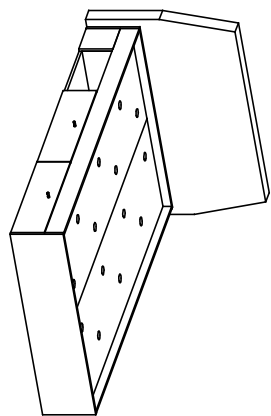

P

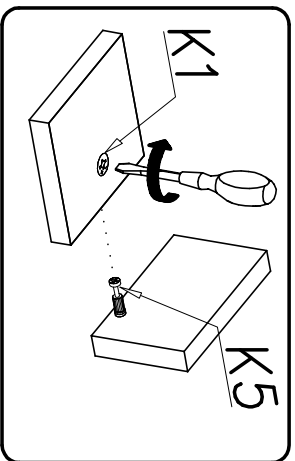
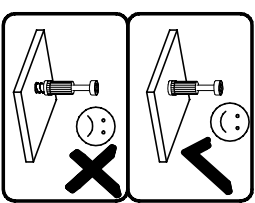
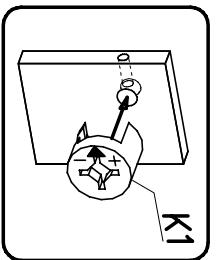
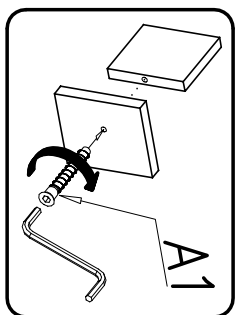
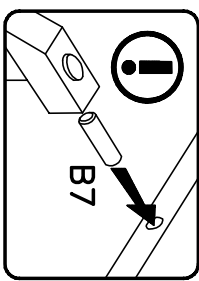
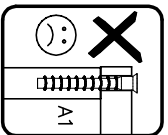
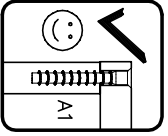
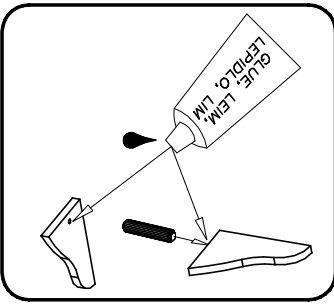
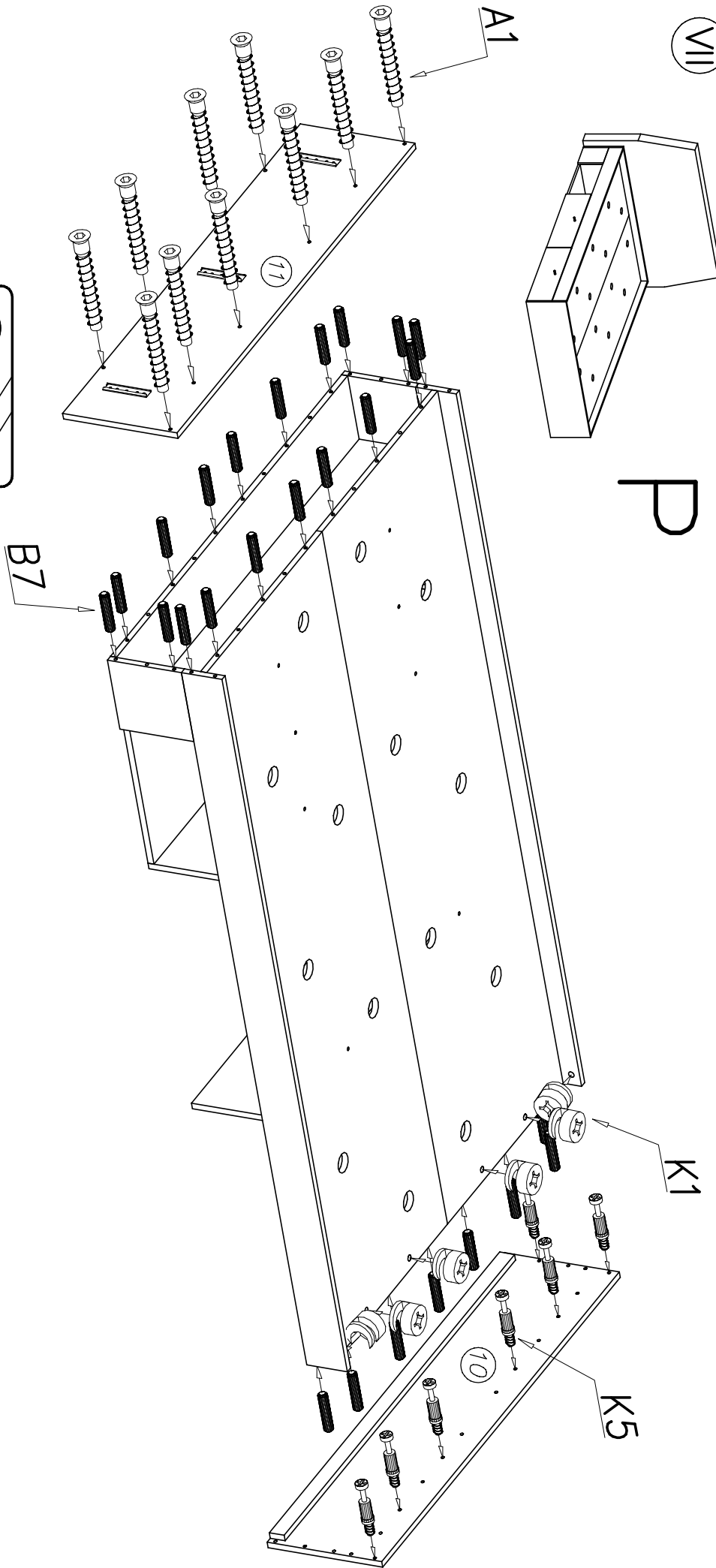

K5

K1

10

B7

11

A1

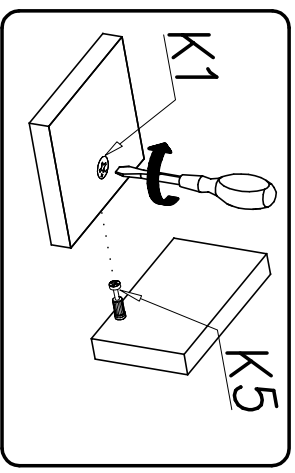
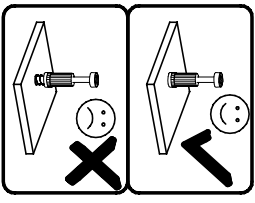
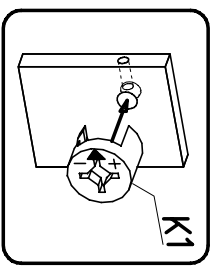
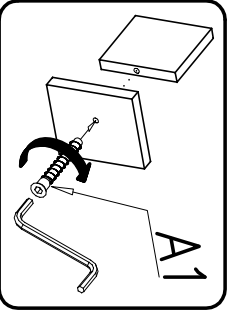
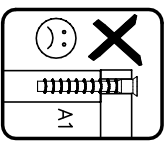
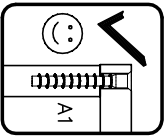
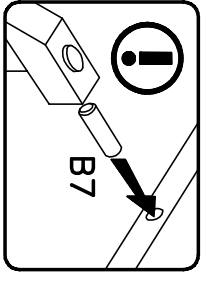
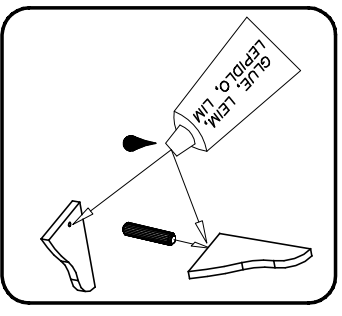
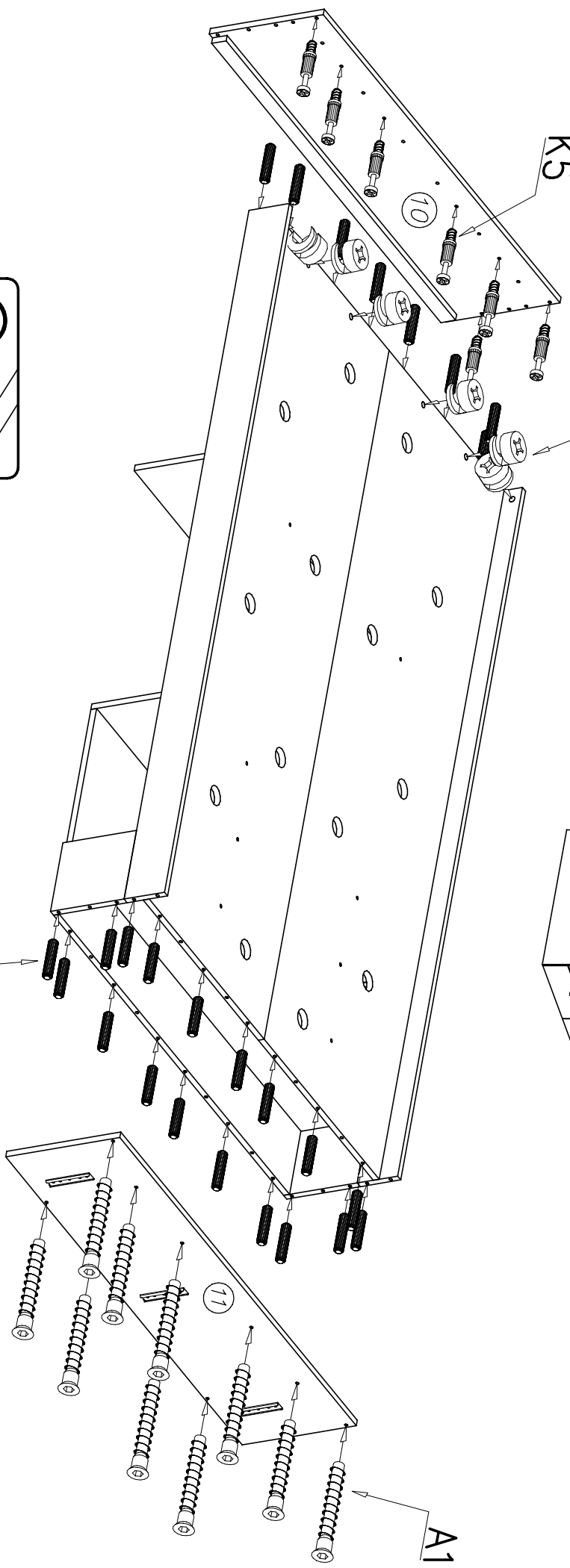
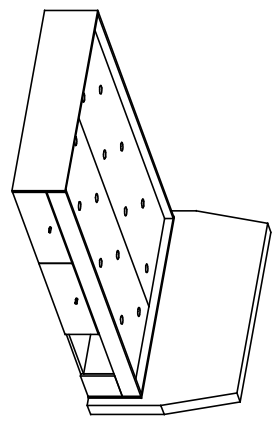



VIII

P

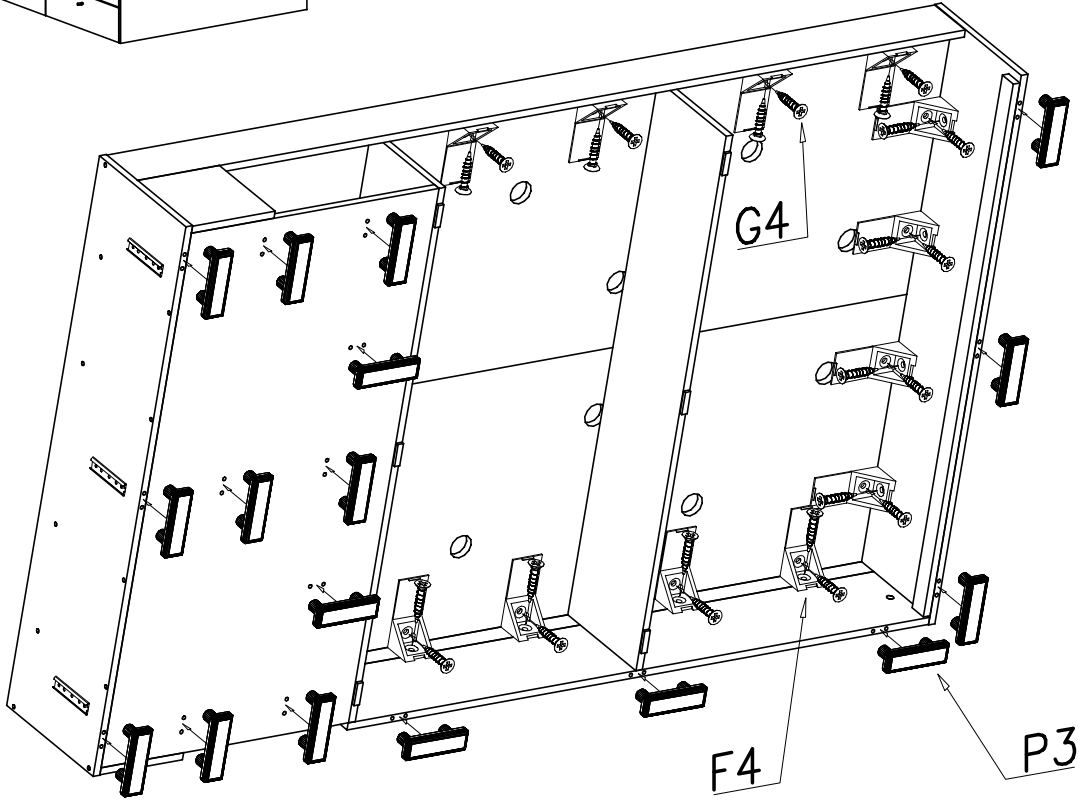
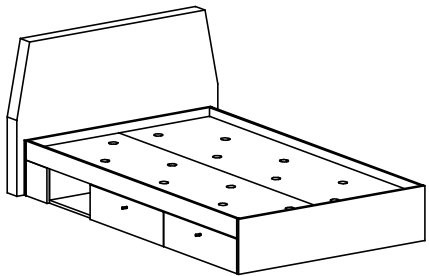

L

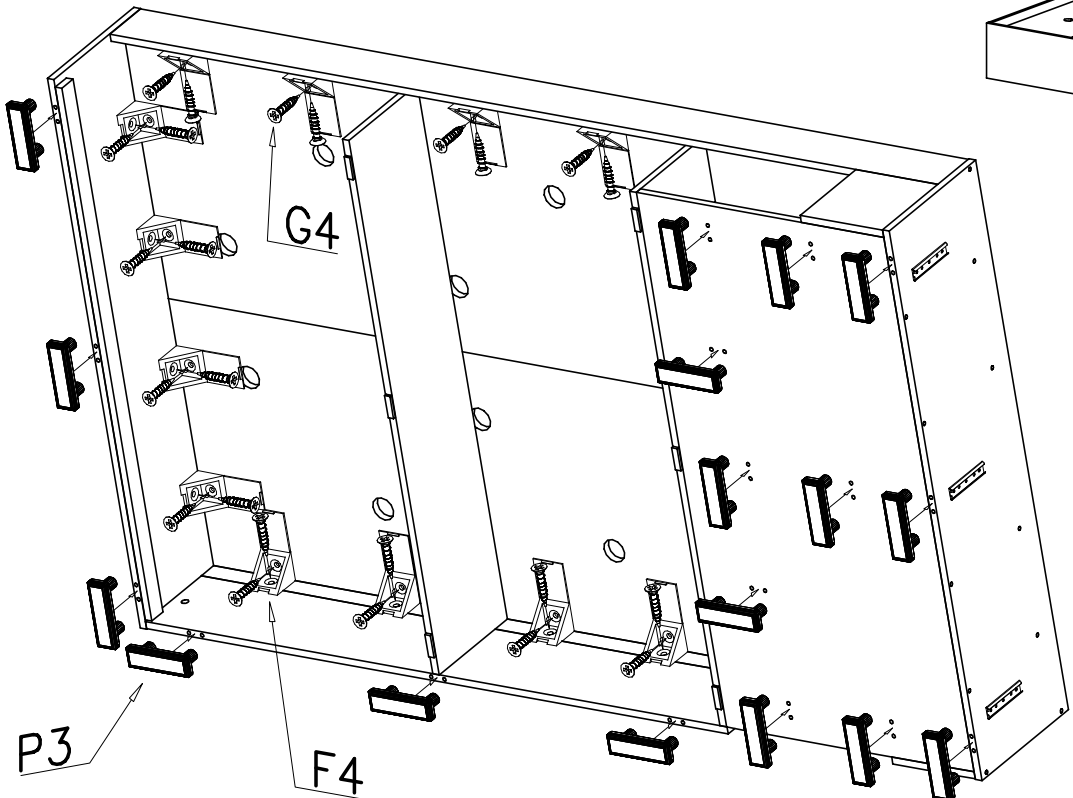
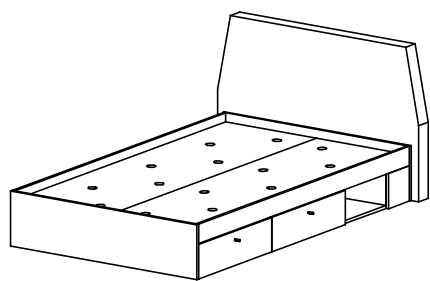

IX

P

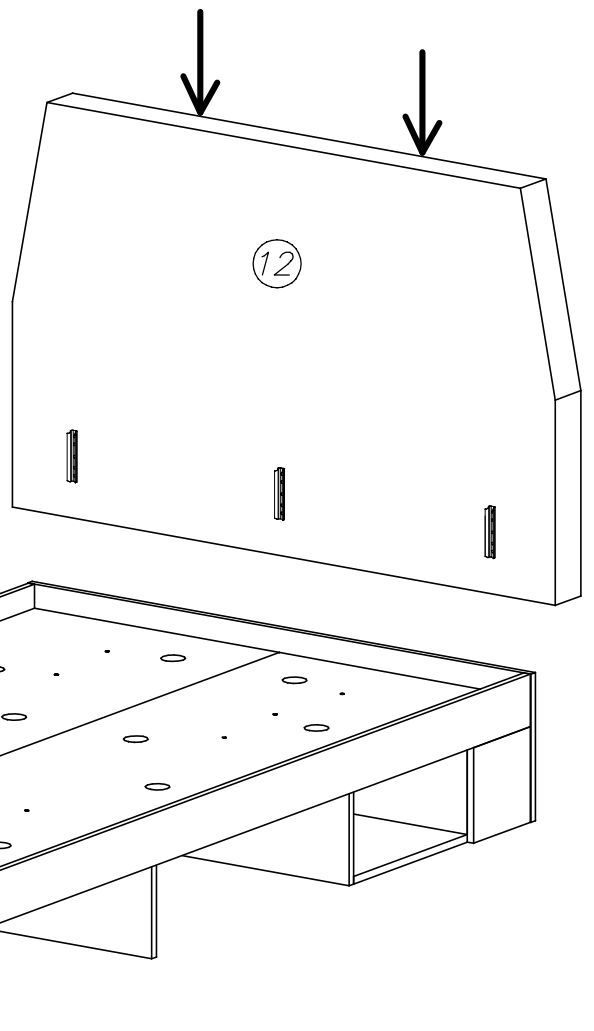
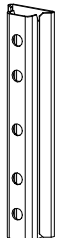
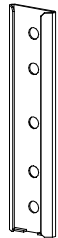
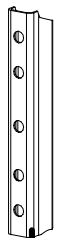
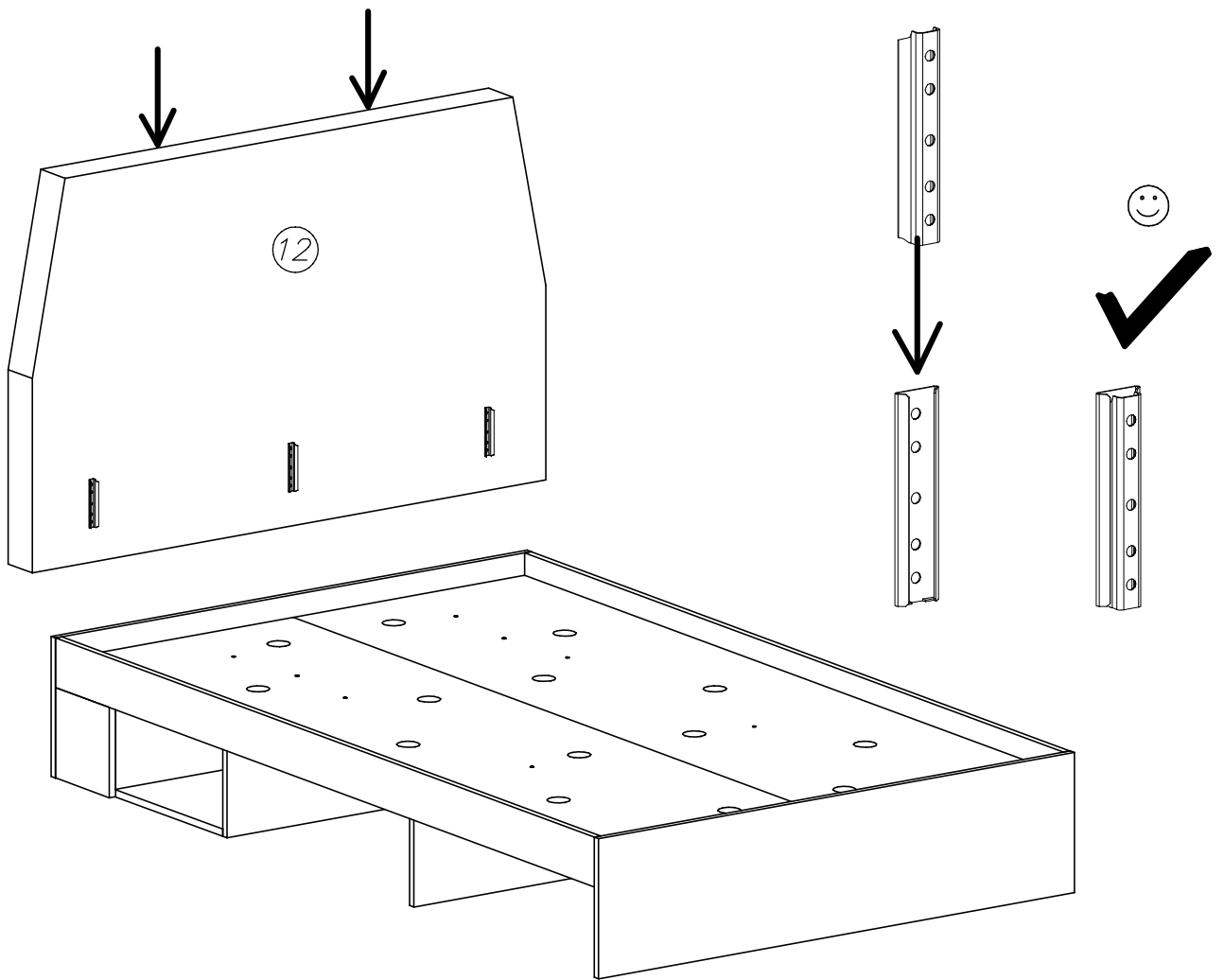

(X)

