

DELTA DL7

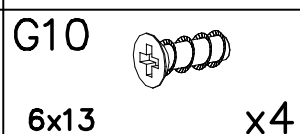

I

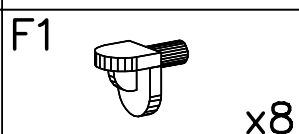
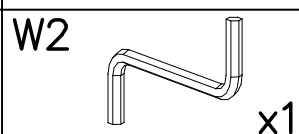
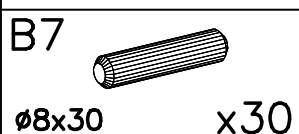
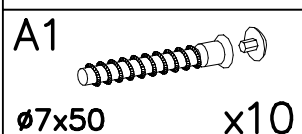
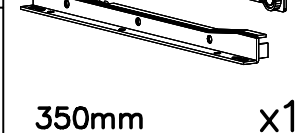
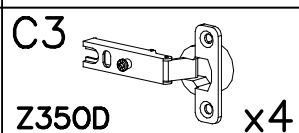
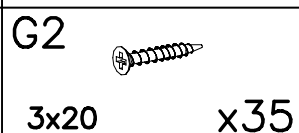
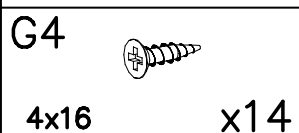
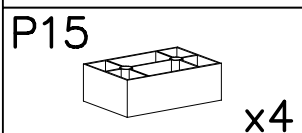
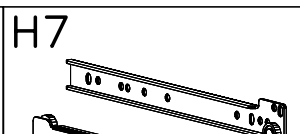
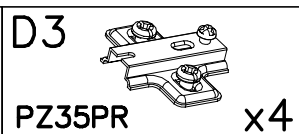
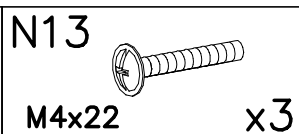
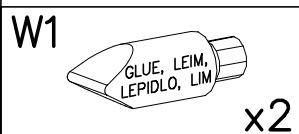
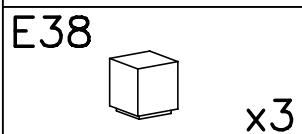
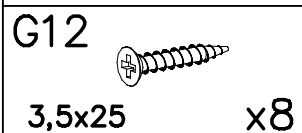
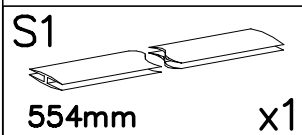
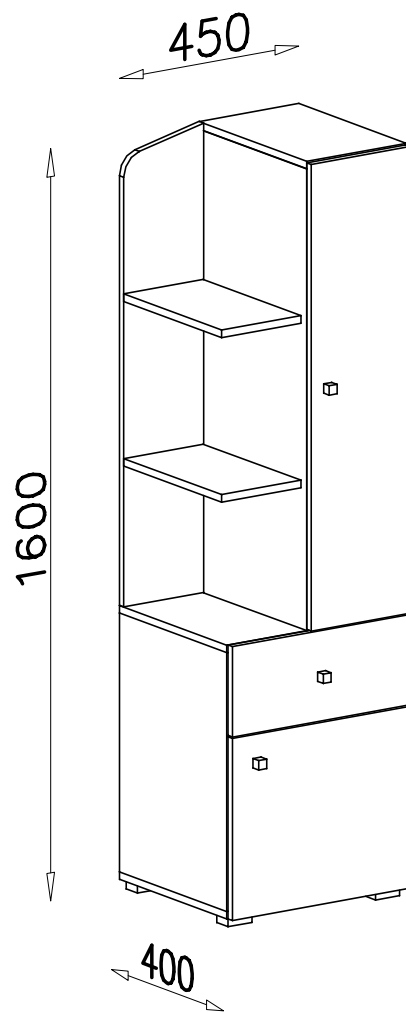
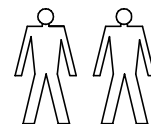
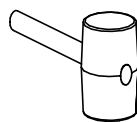
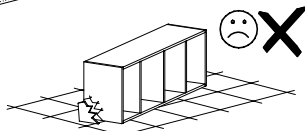
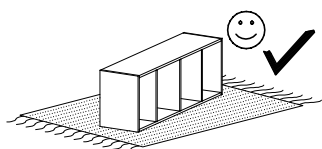
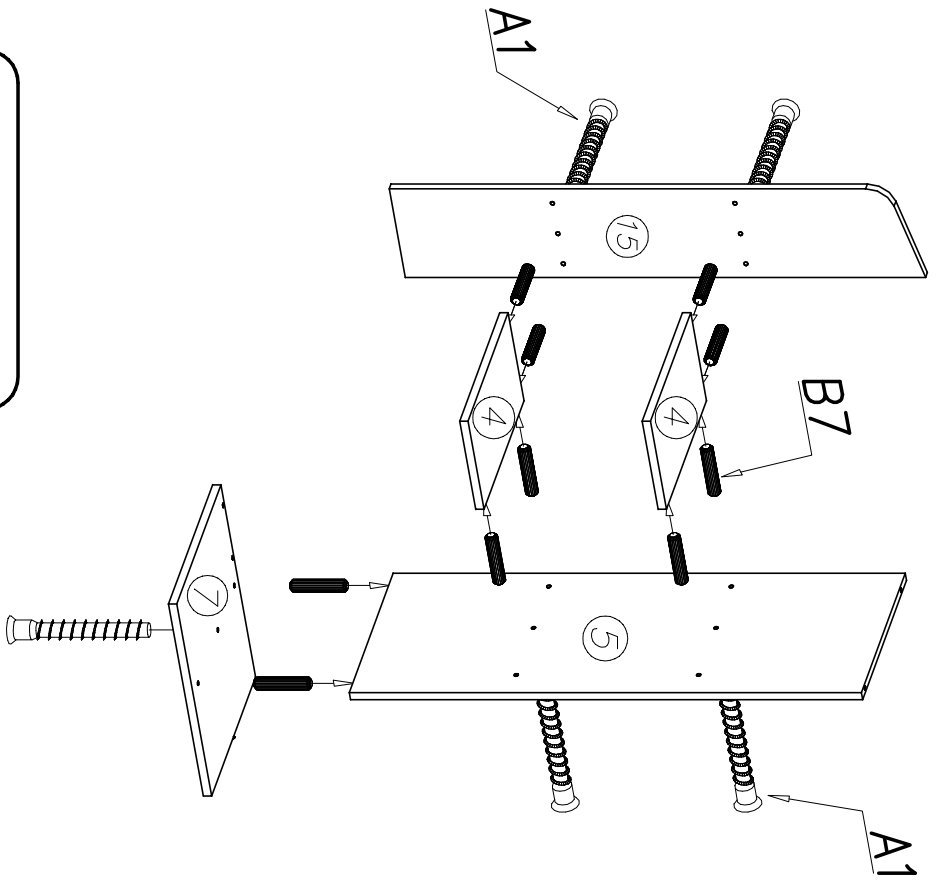
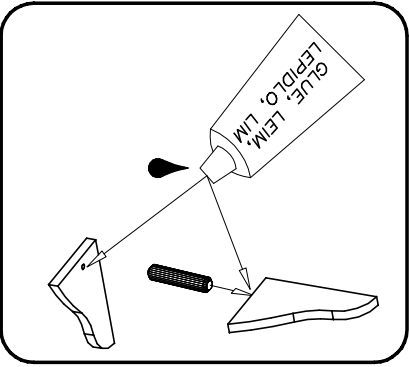

II

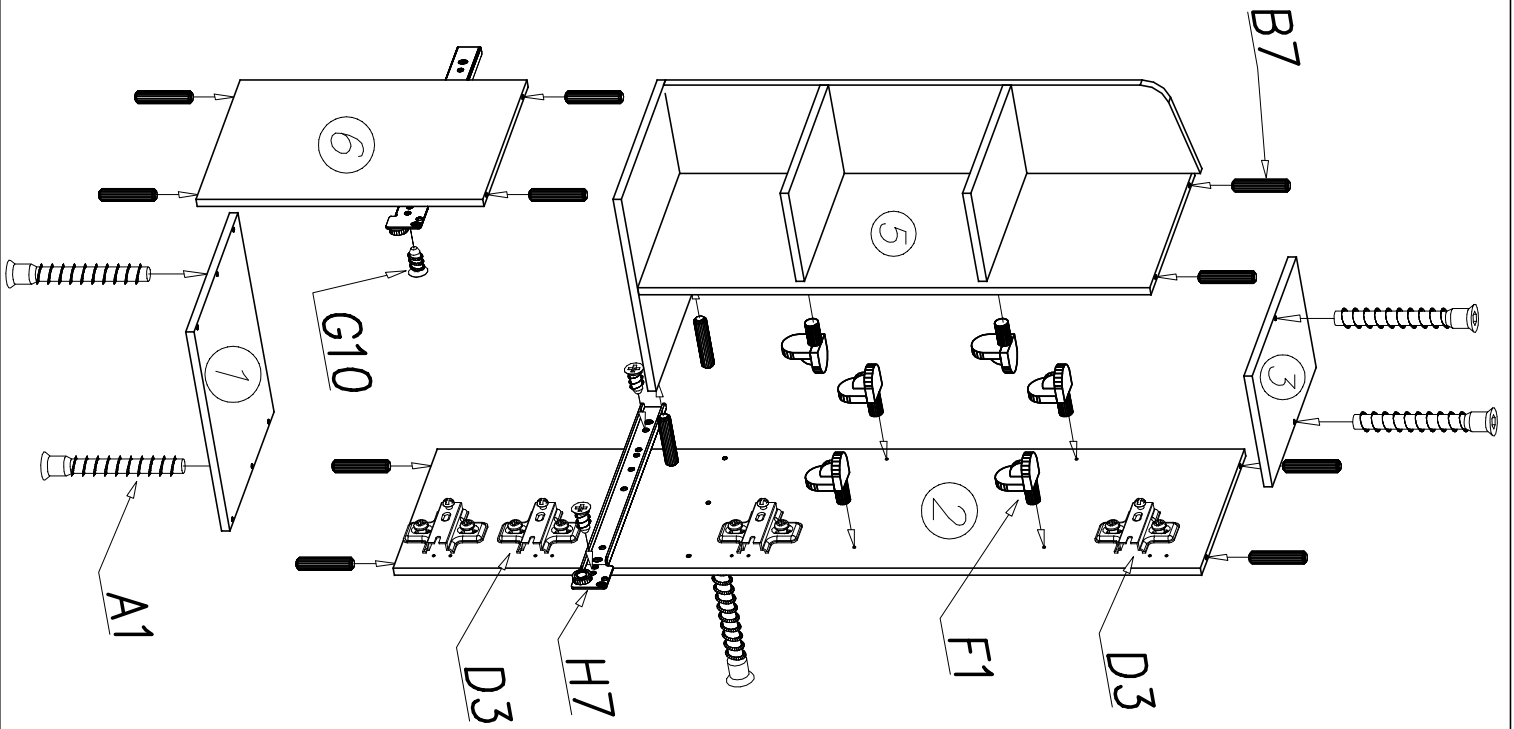

III

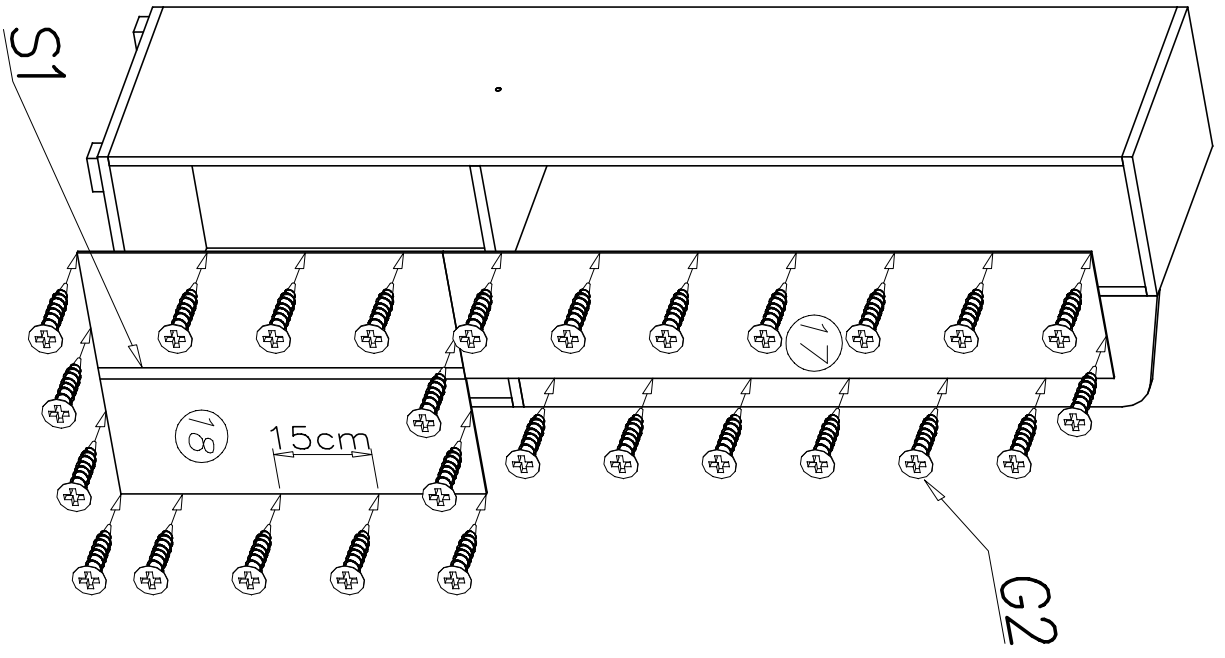

IV

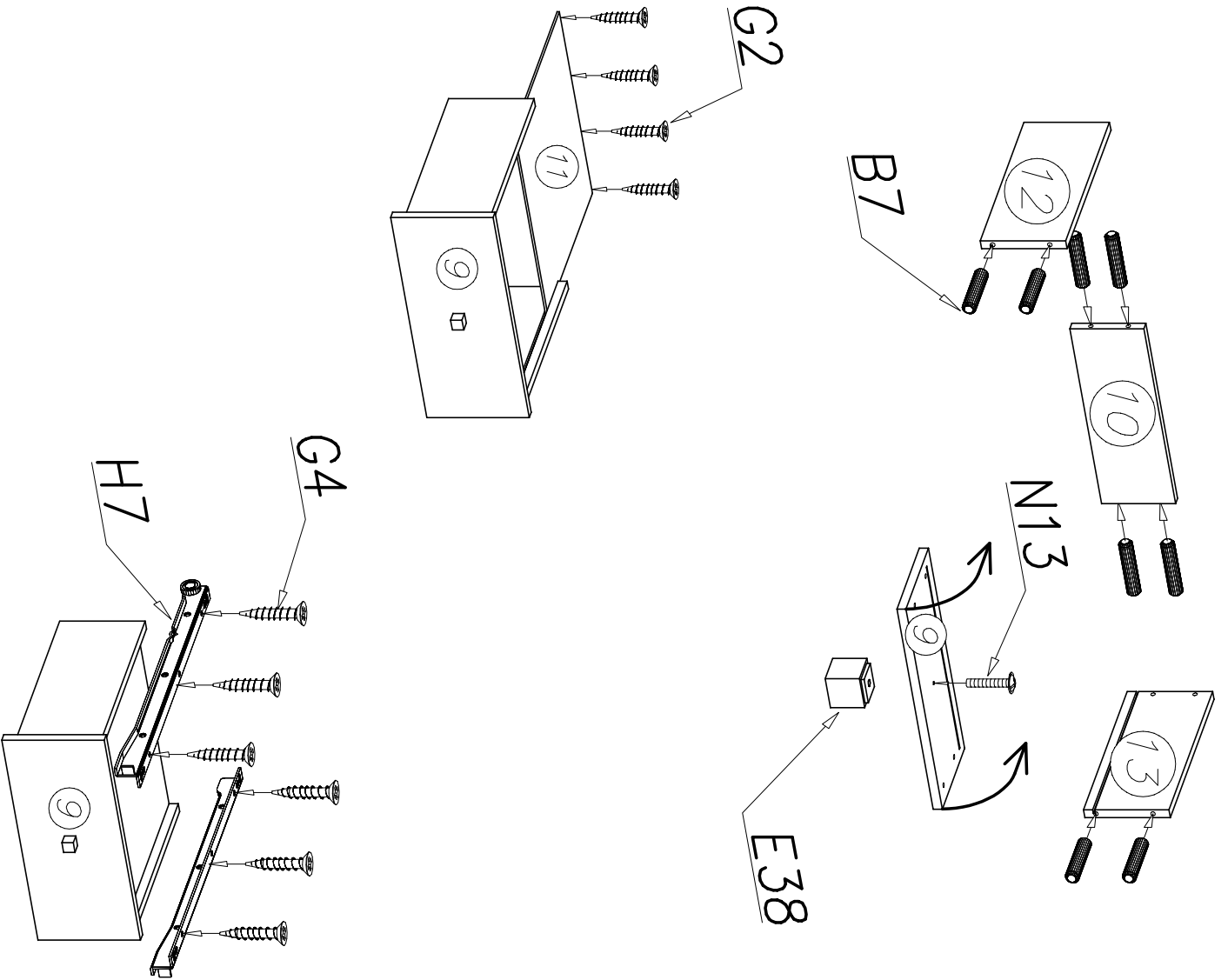

V

