

LUCA LC 3

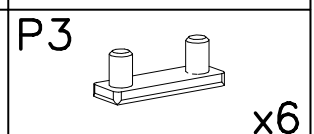

I

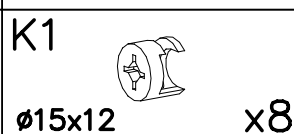
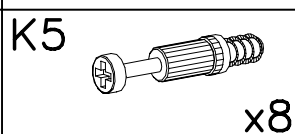
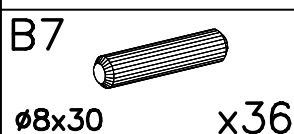
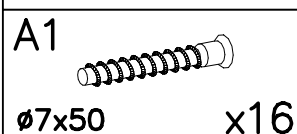
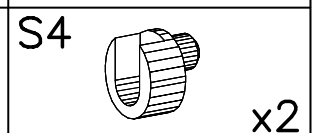
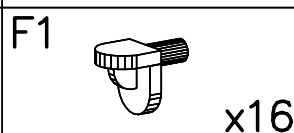
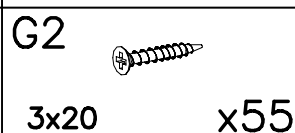
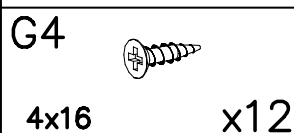
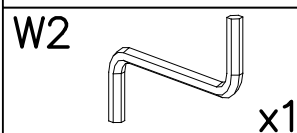
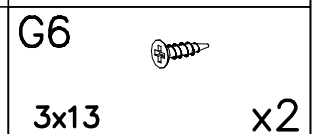
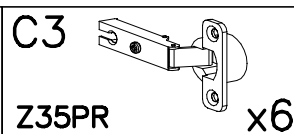
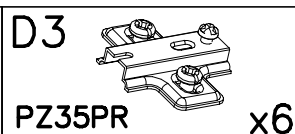
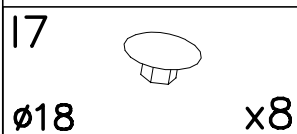
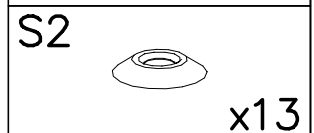
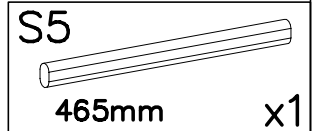
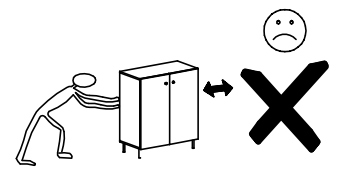
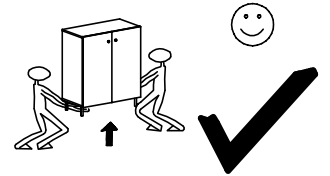
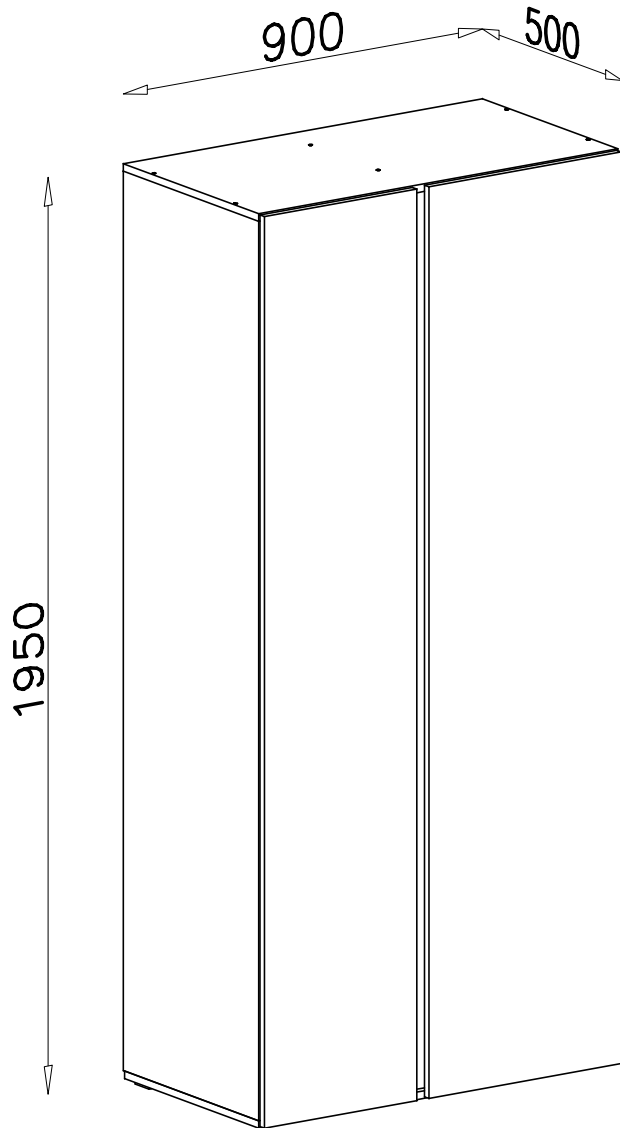
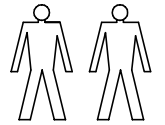
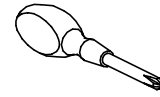
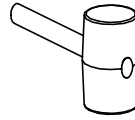
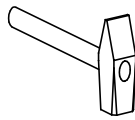
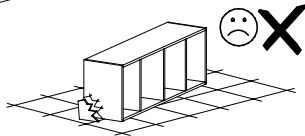
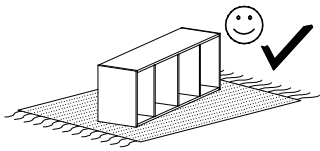
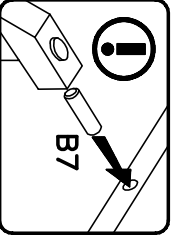
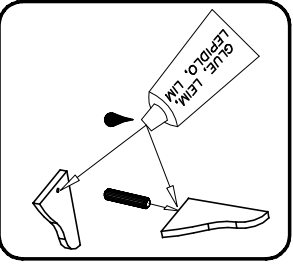
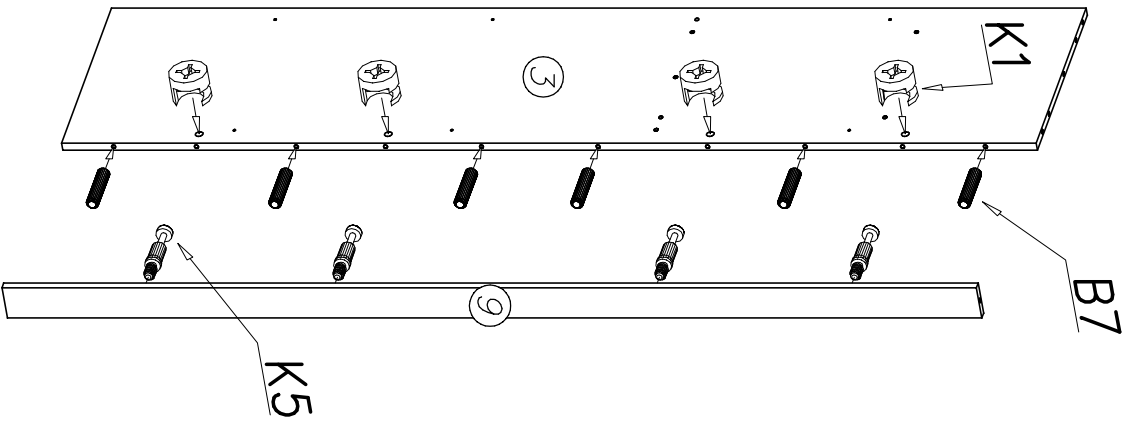

II

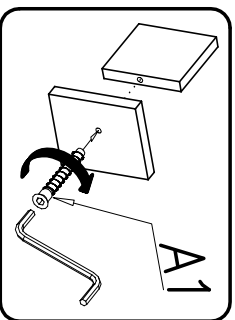
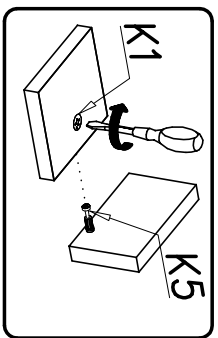
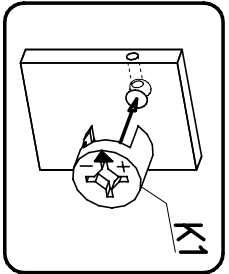
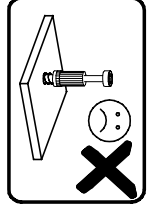
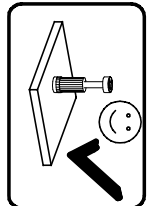
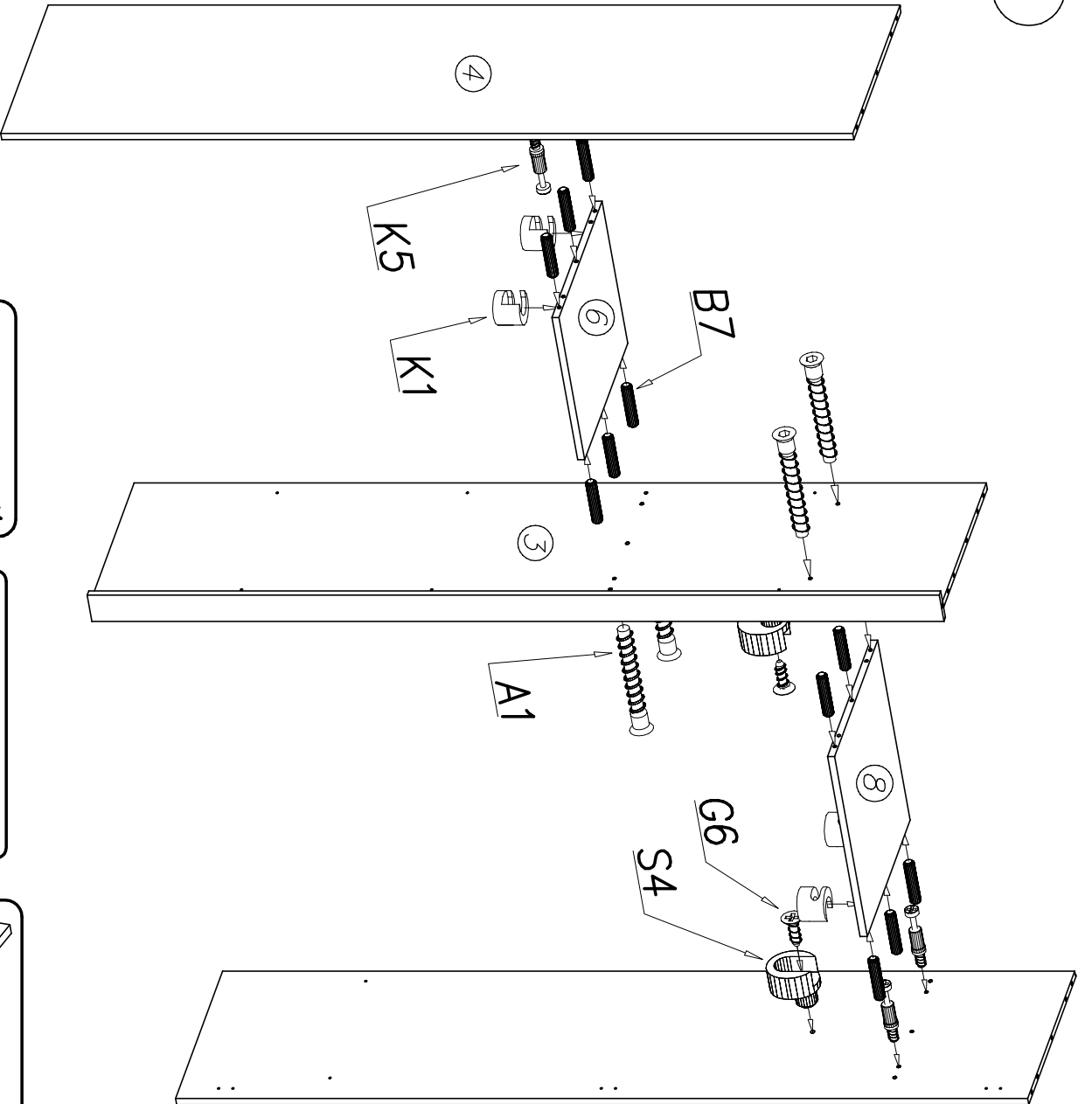

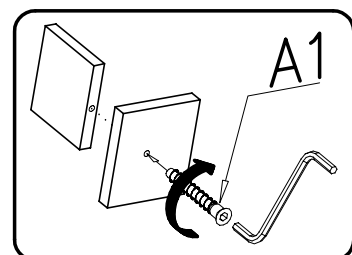
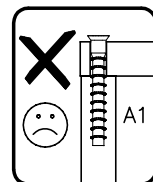
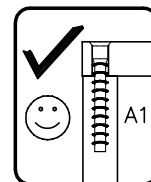
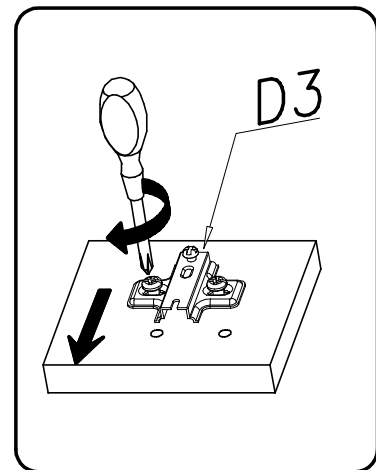
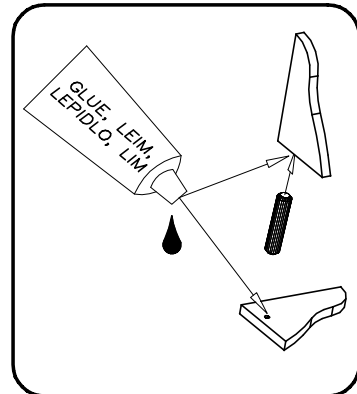
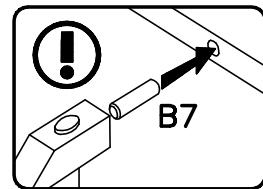
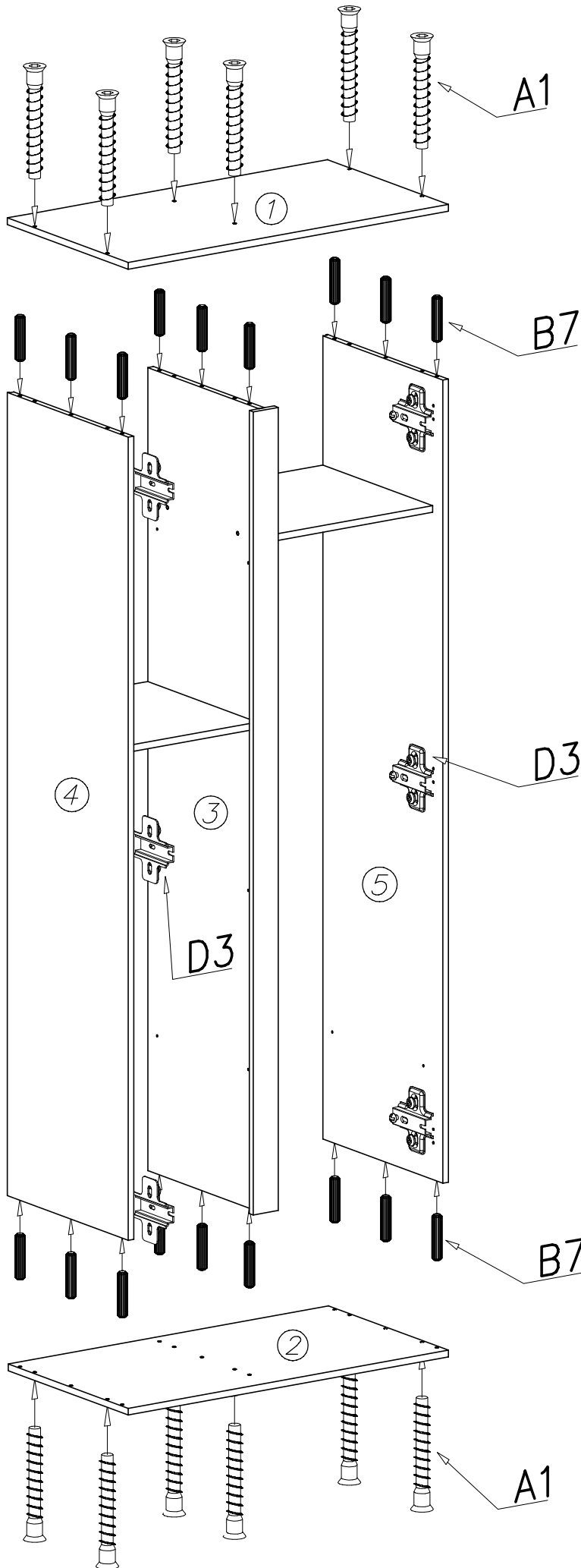

IV

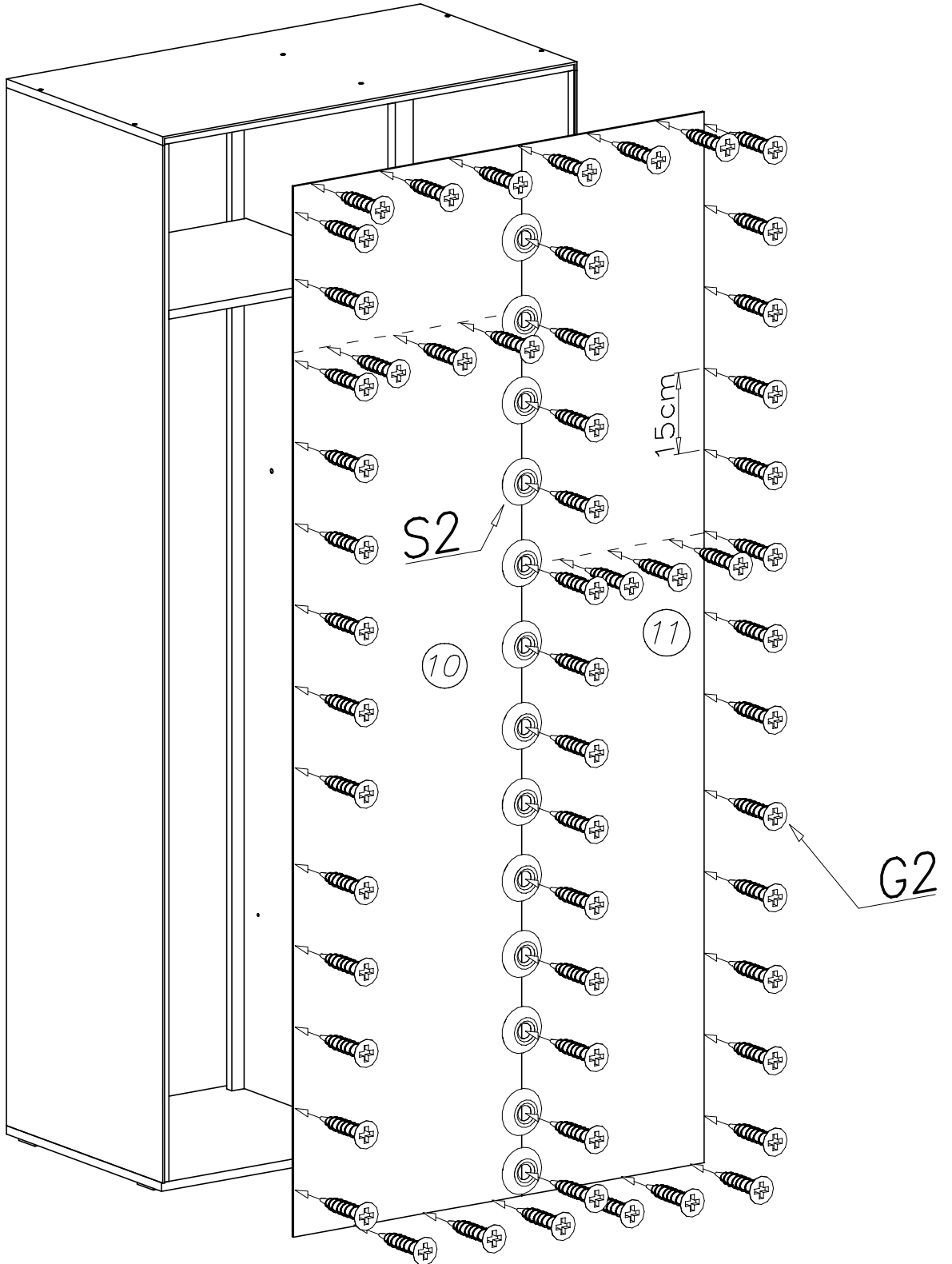
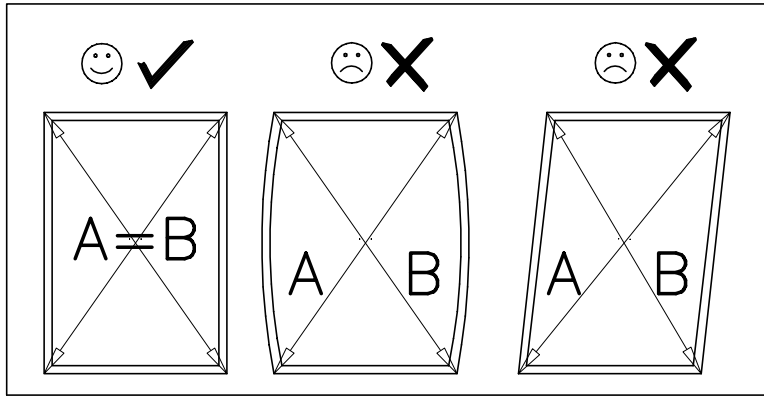

P3

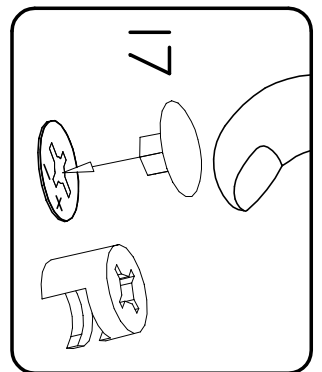
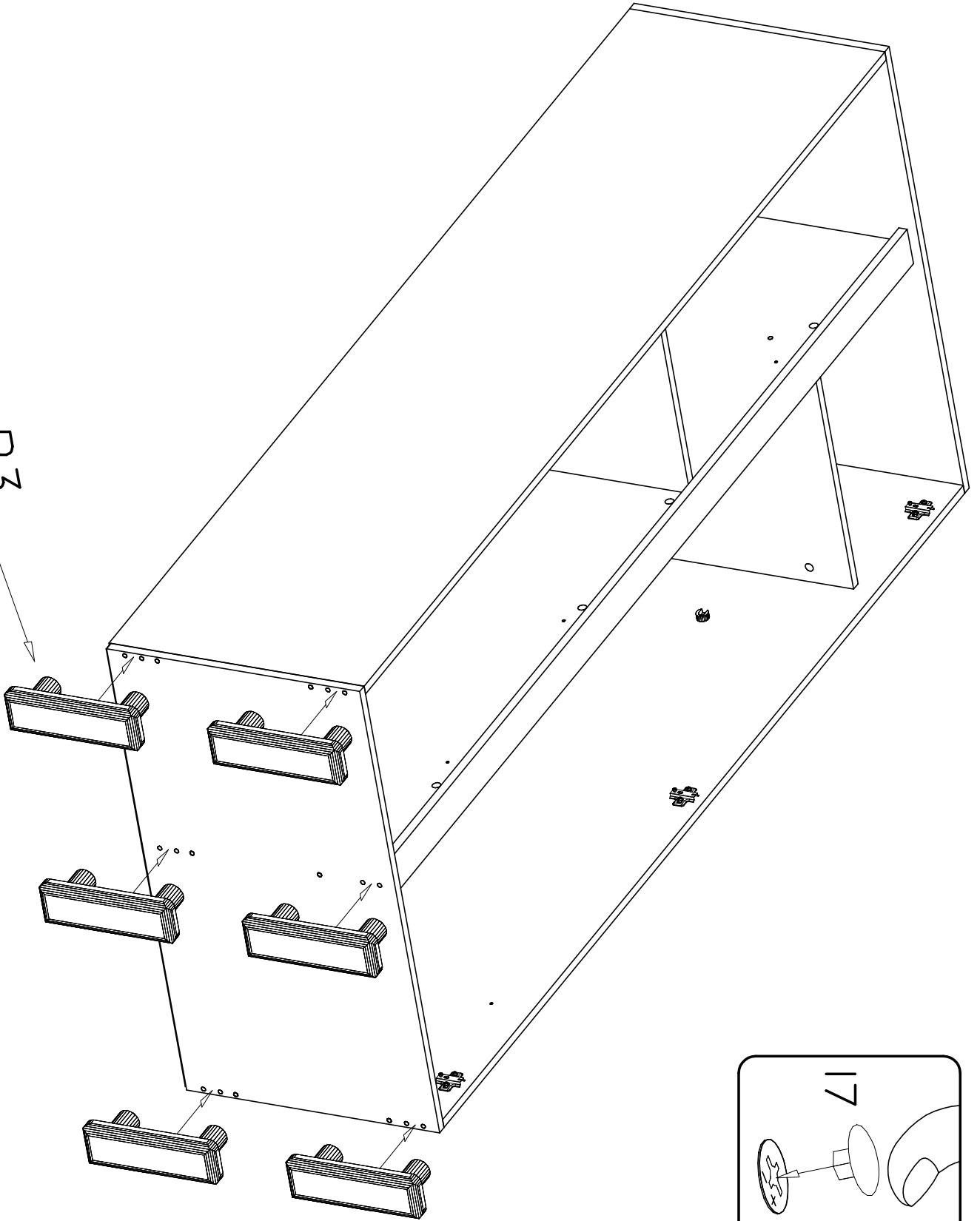

VI

