

NEXT

NX 1

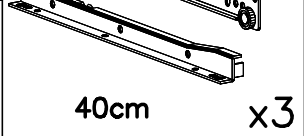

I

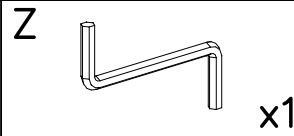
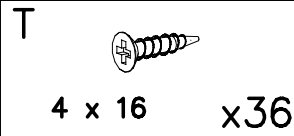
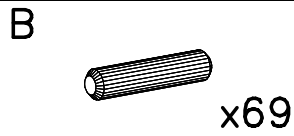
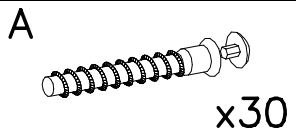
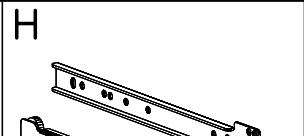
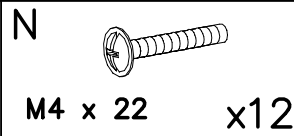
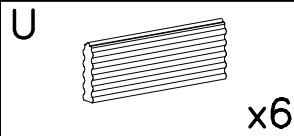
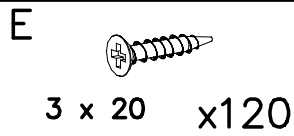
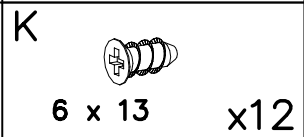
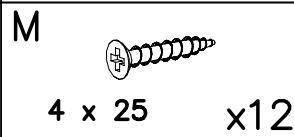
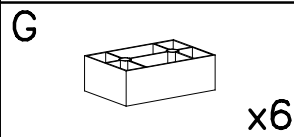
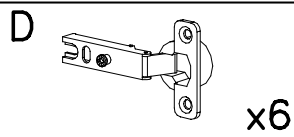
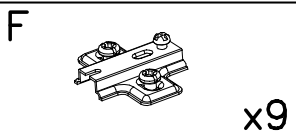
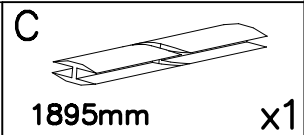
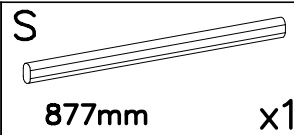
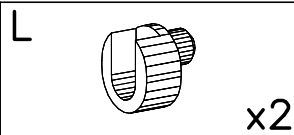
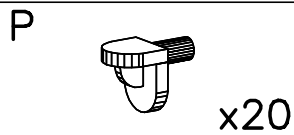
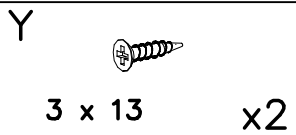
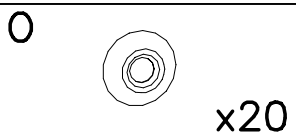
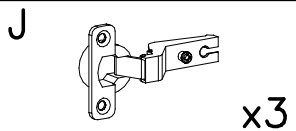
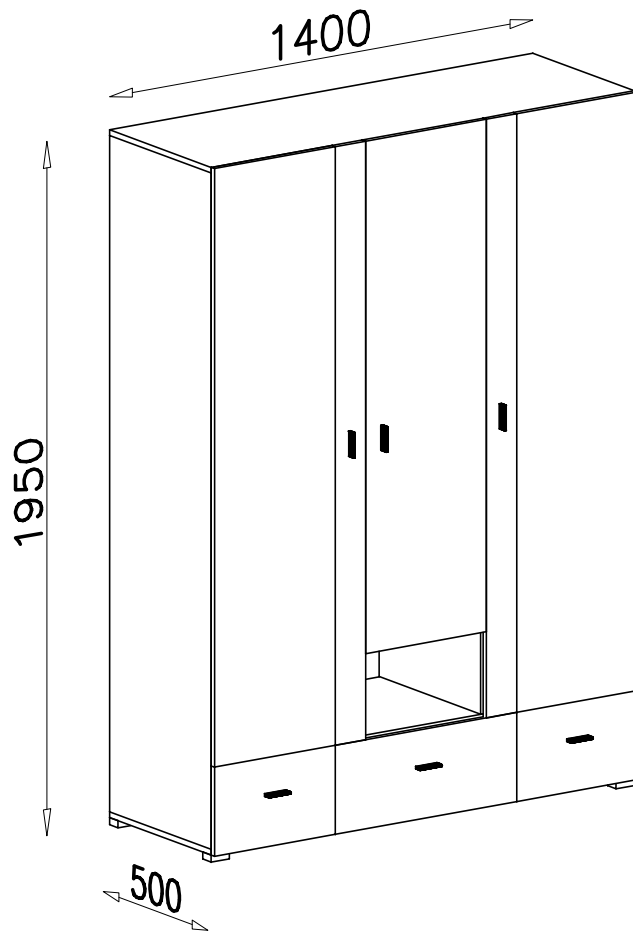
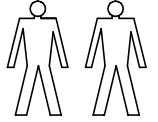
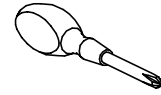
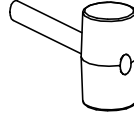
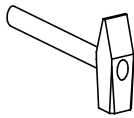
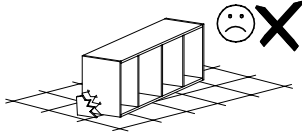
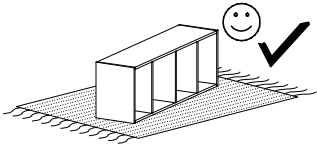
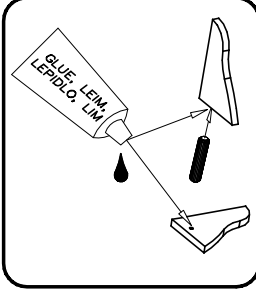
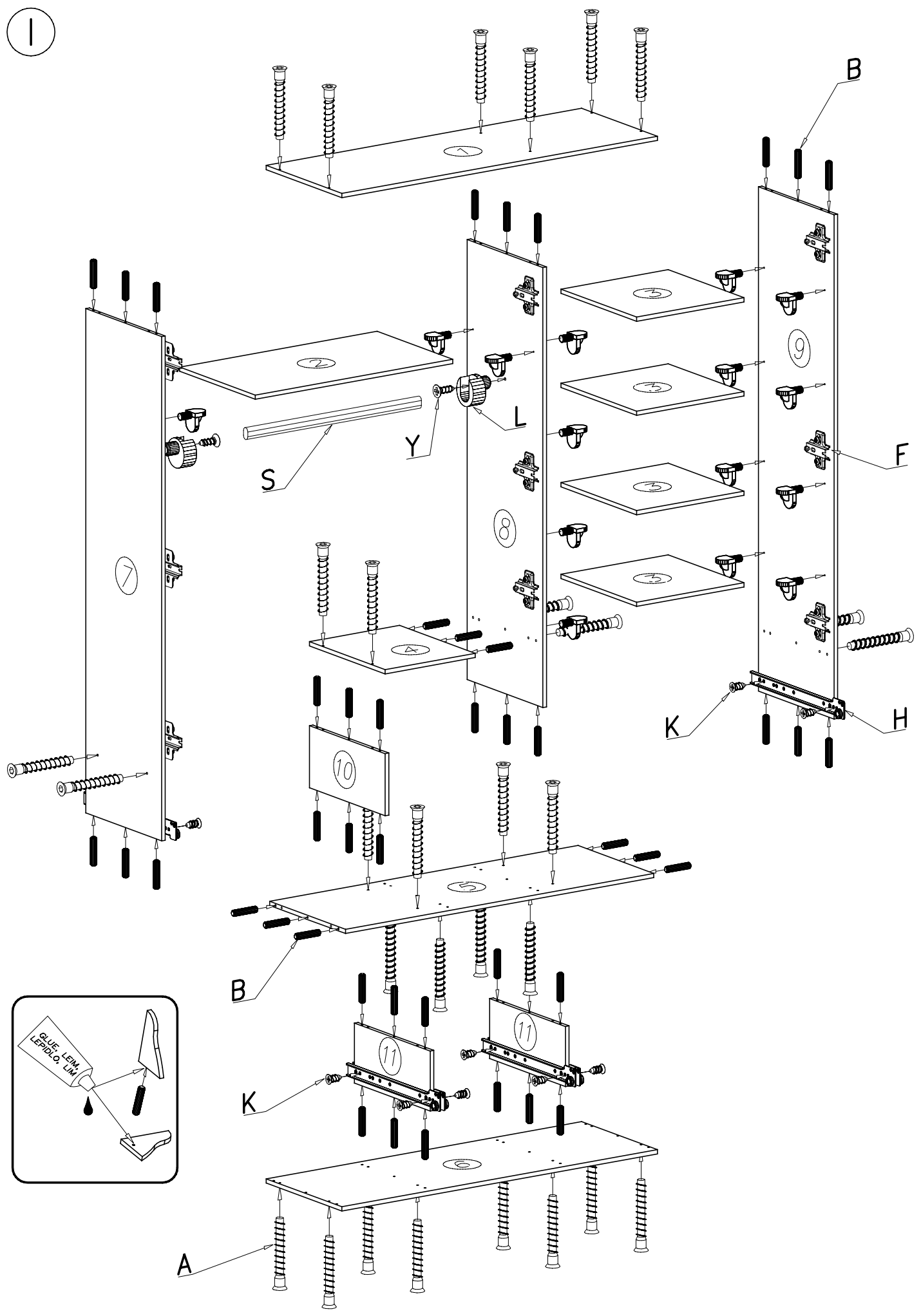

II

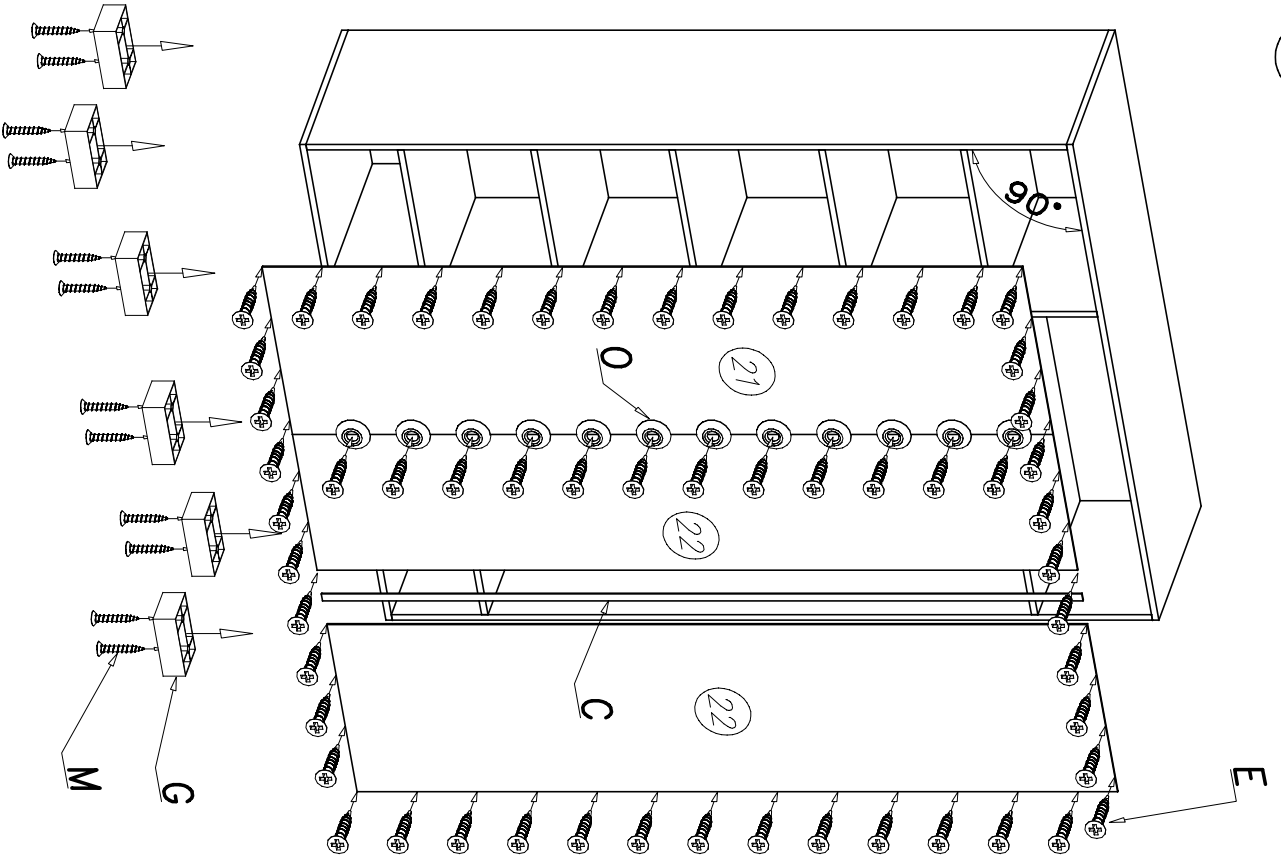

III

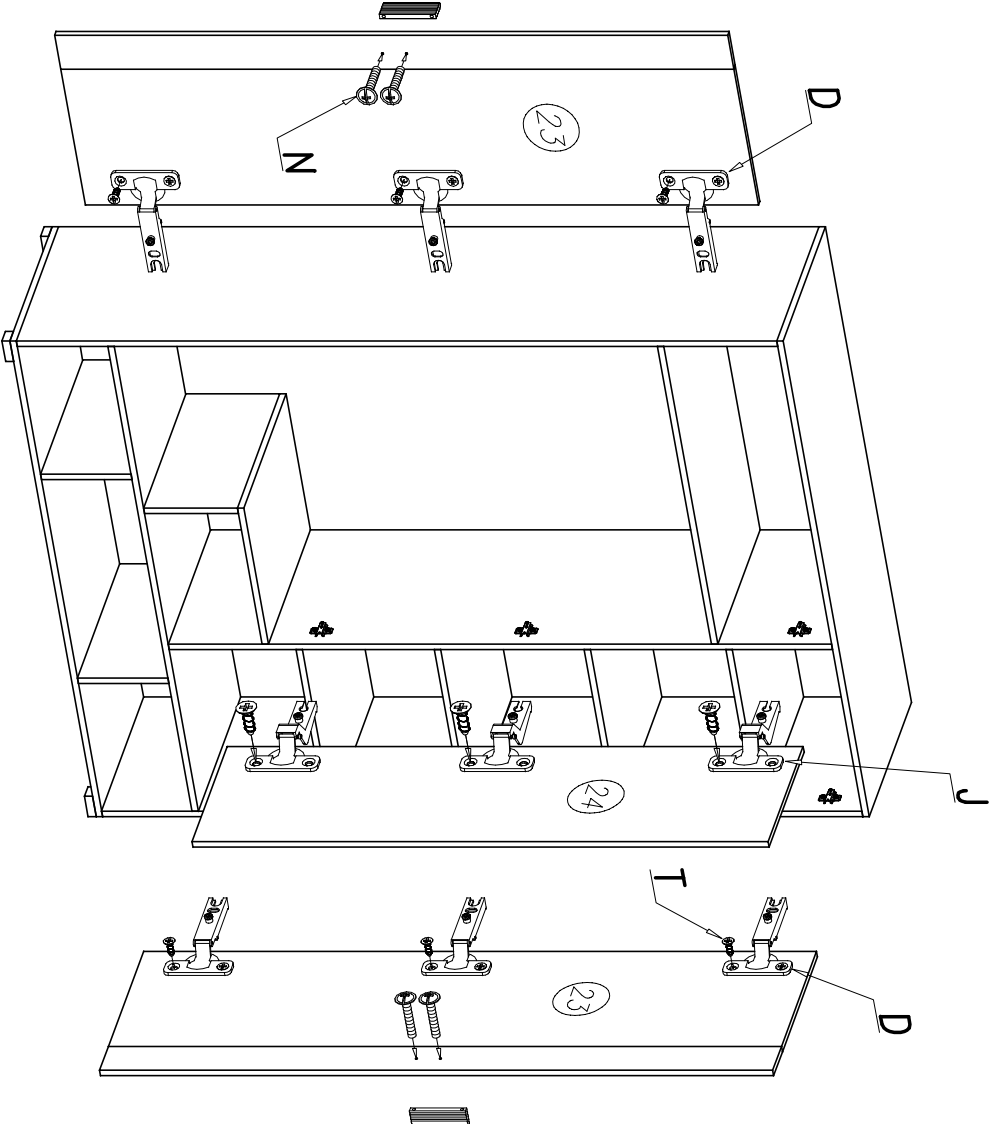

IV

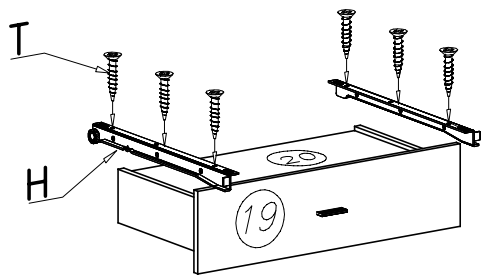
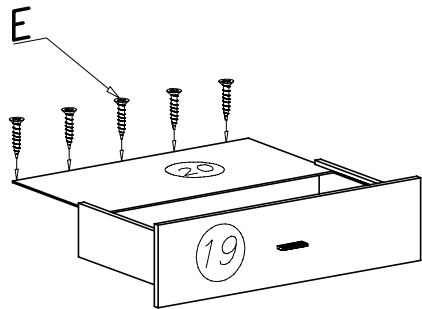
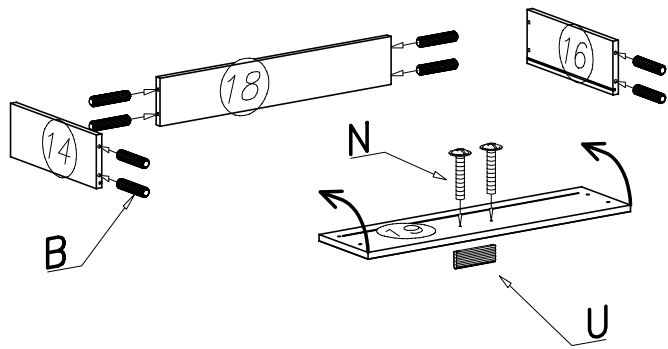

V

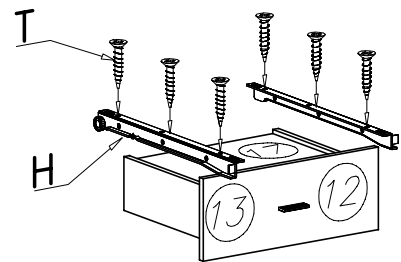
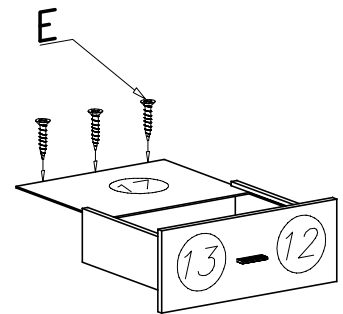
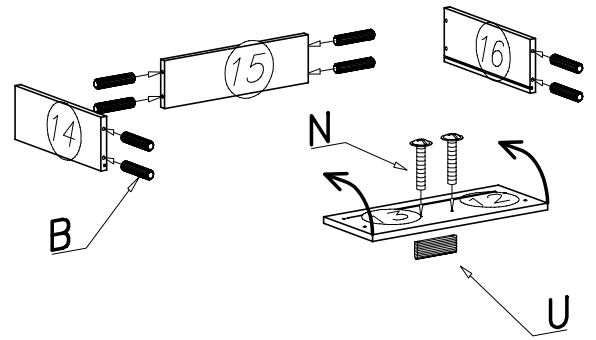

VI

