

# OPTIMO OP 5

PRZED ROZPOCZĘCIEM MONTAŻU ZAPOZNAĆ SIĘ Z INSTRUKCJĄ

Narzędzia niezbędne do montażu (nie dostarczane przez producenta)

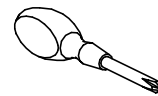
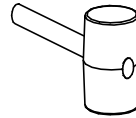
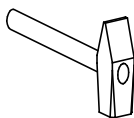
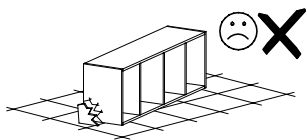
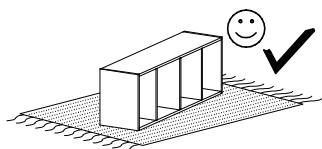

MONTOWAĆ NA MIEKKIM PODŁOŻU TYPU: KOC, DYWAN.

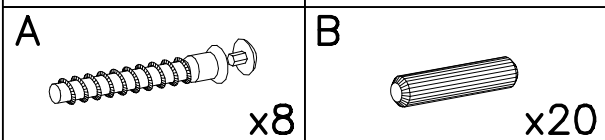
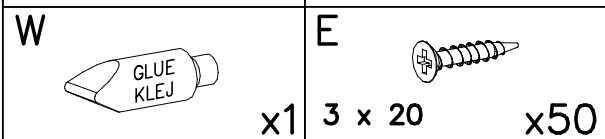
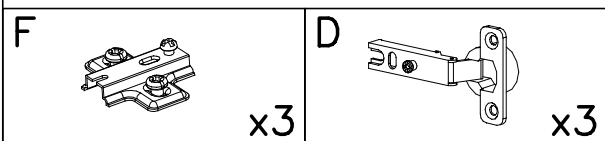
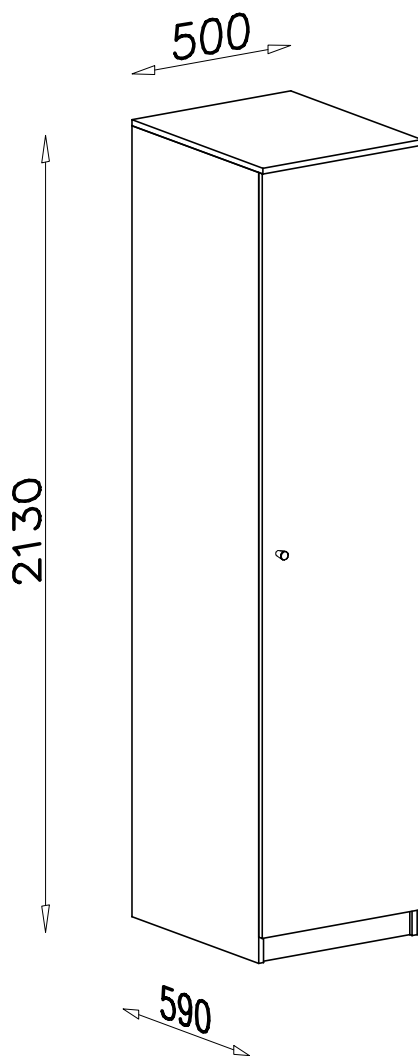
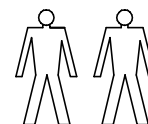

I

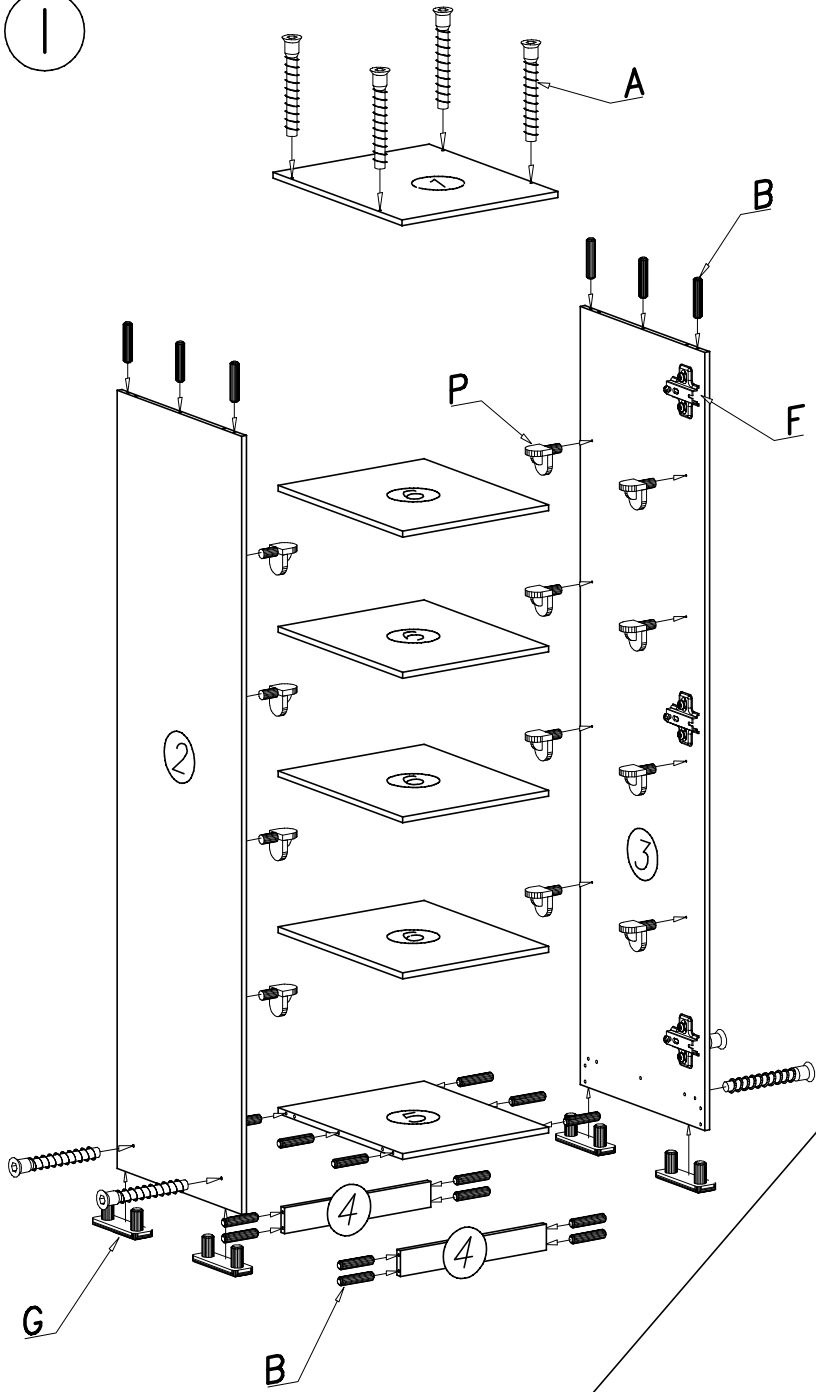

II

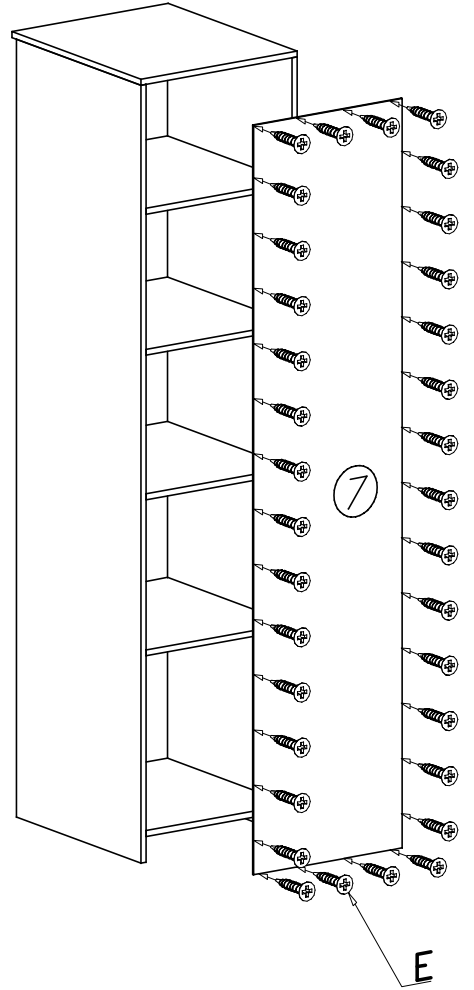

III

