

PIXEL PX 4 P/L

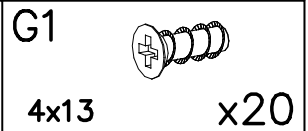

1

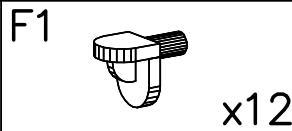
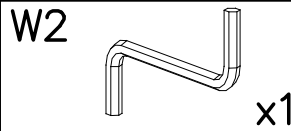
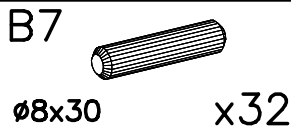
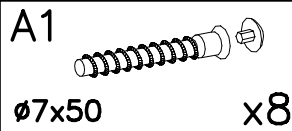
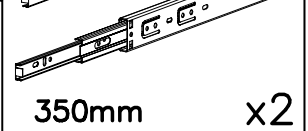
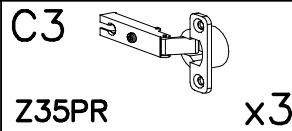
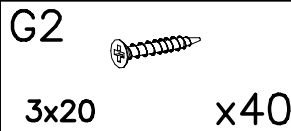
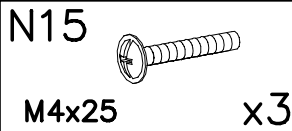
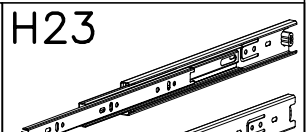
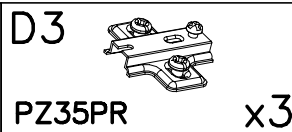
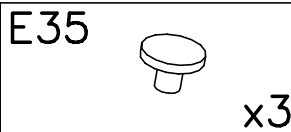
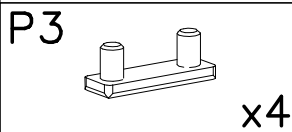
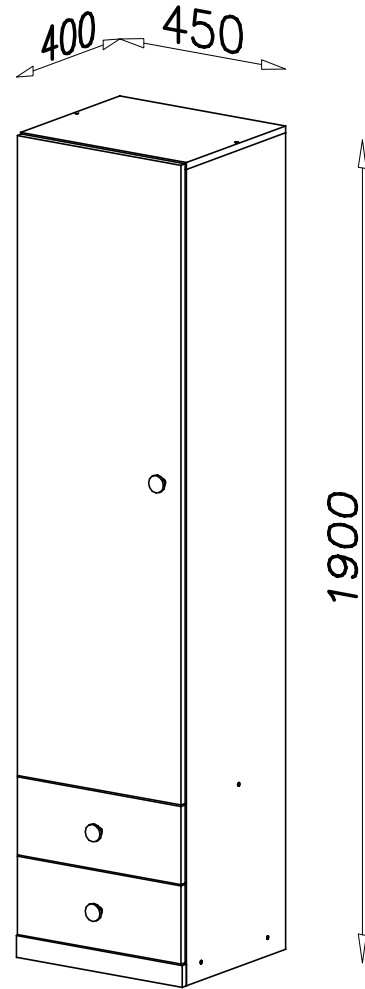
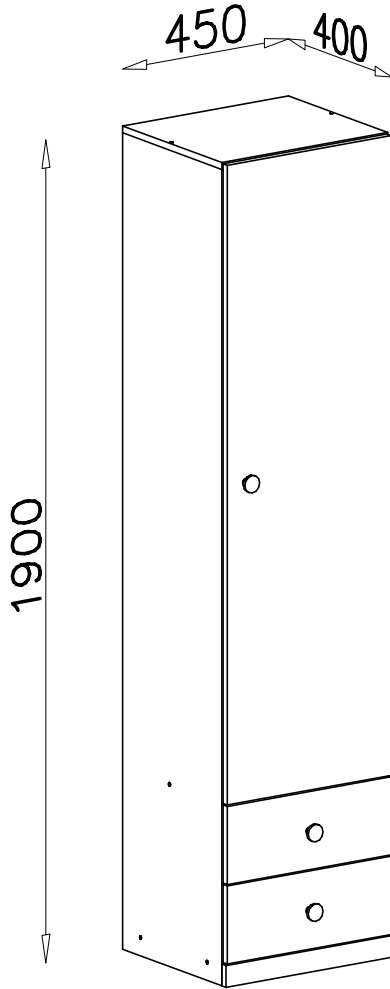
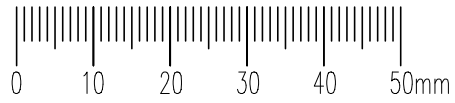
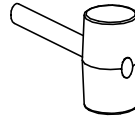
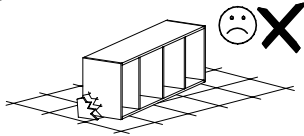
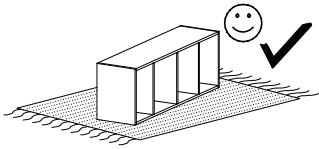
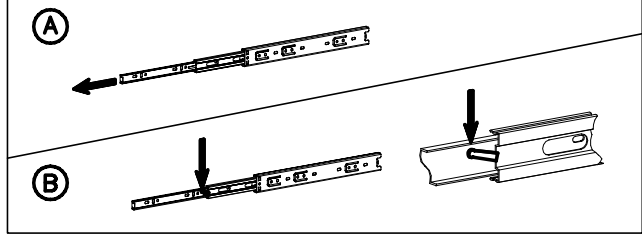
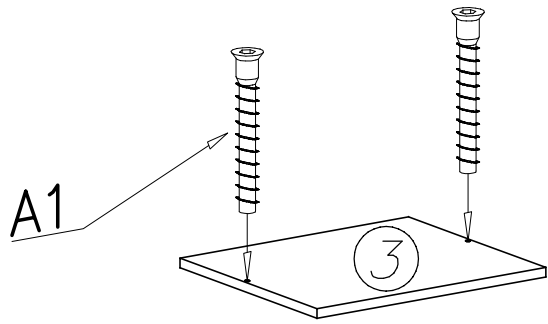

B1

F1

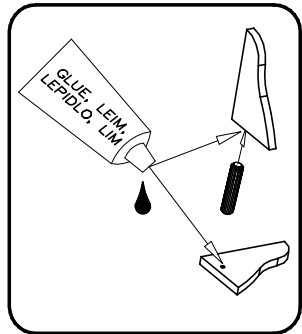
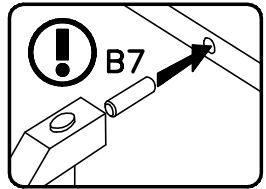

5

4

7

H23

G1

12

6

P3

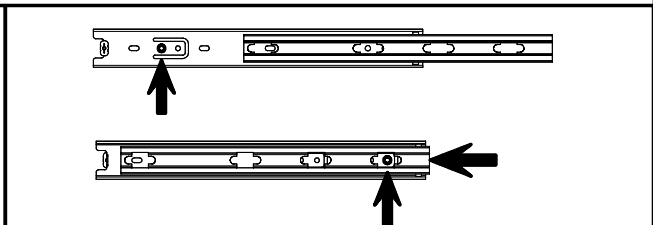
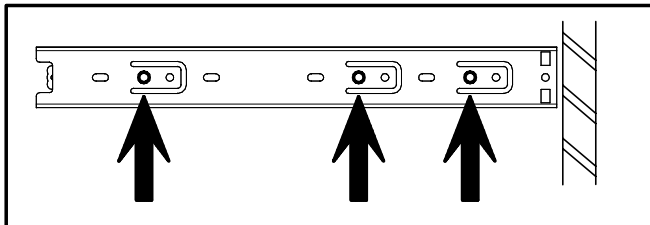

II

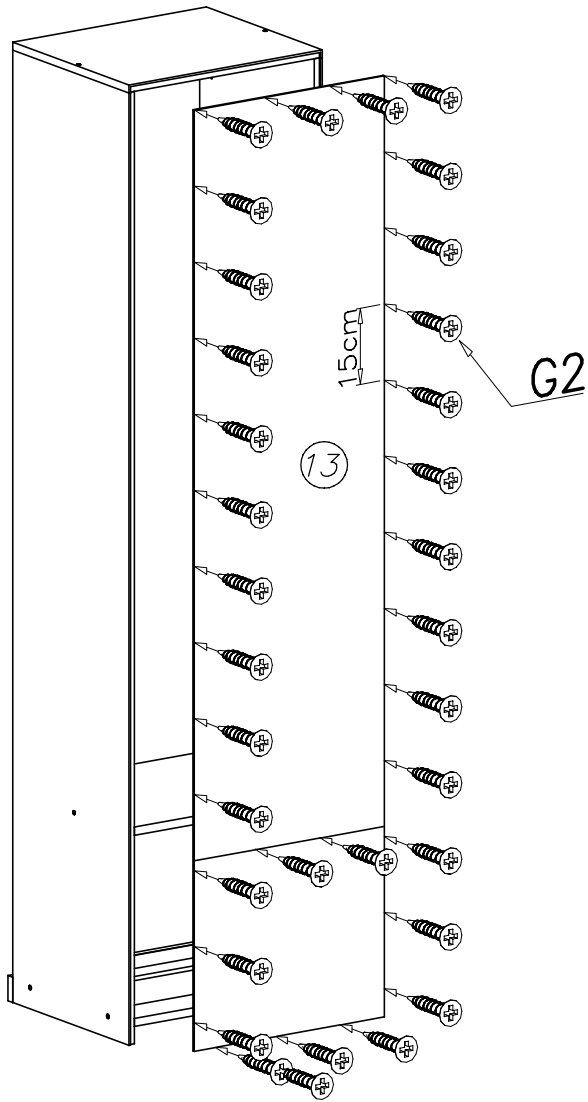

III

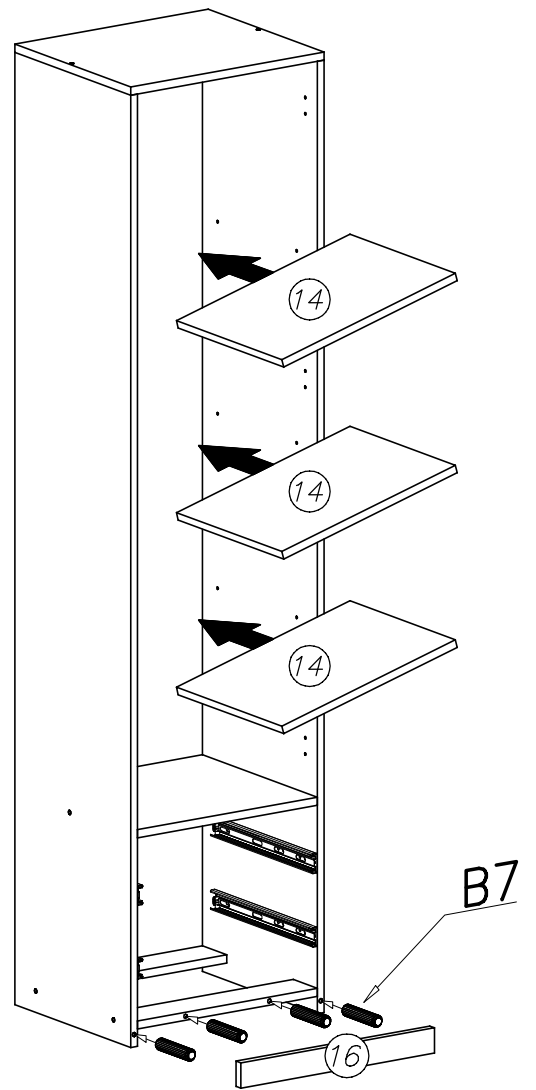

IV

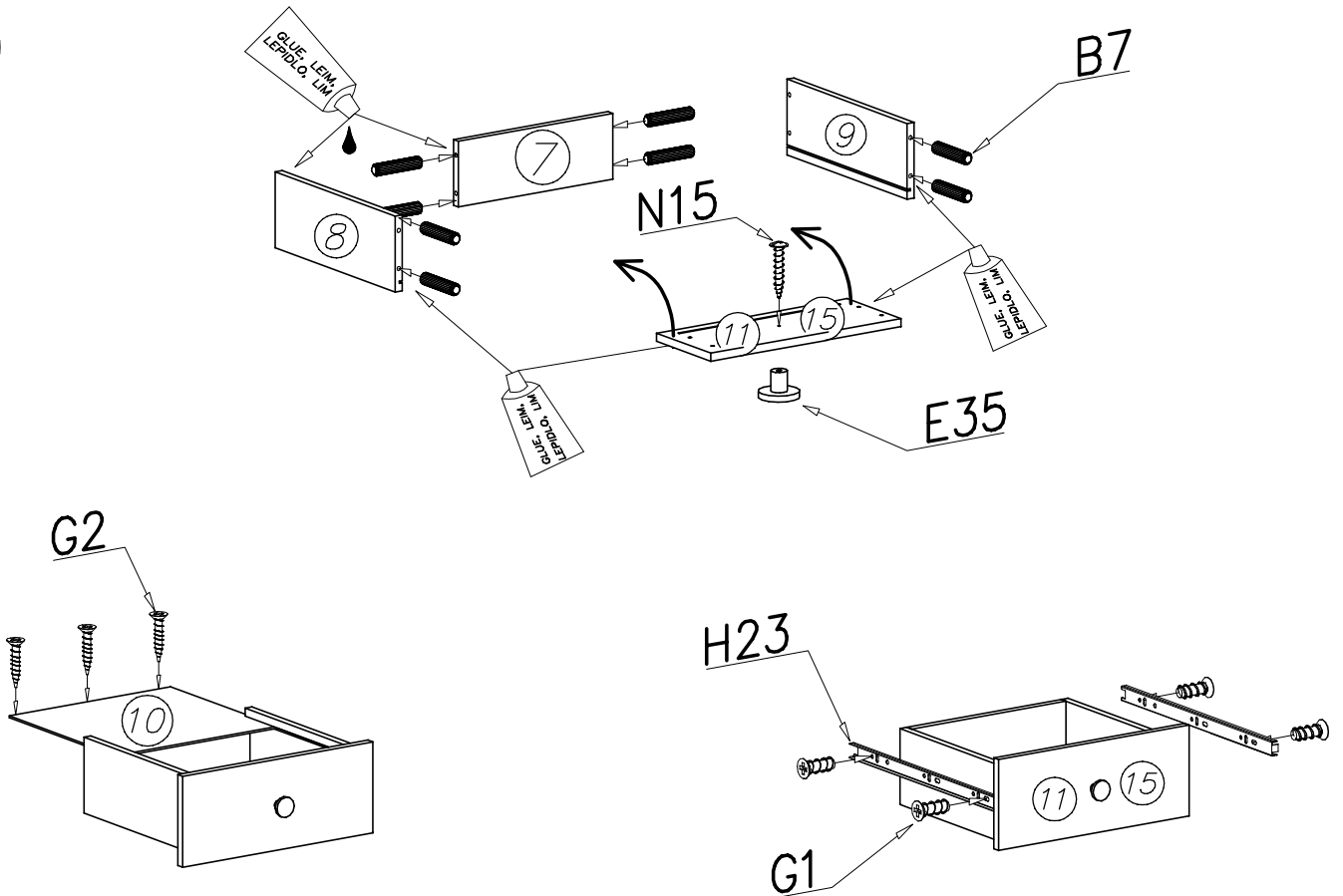

V

E35

N15

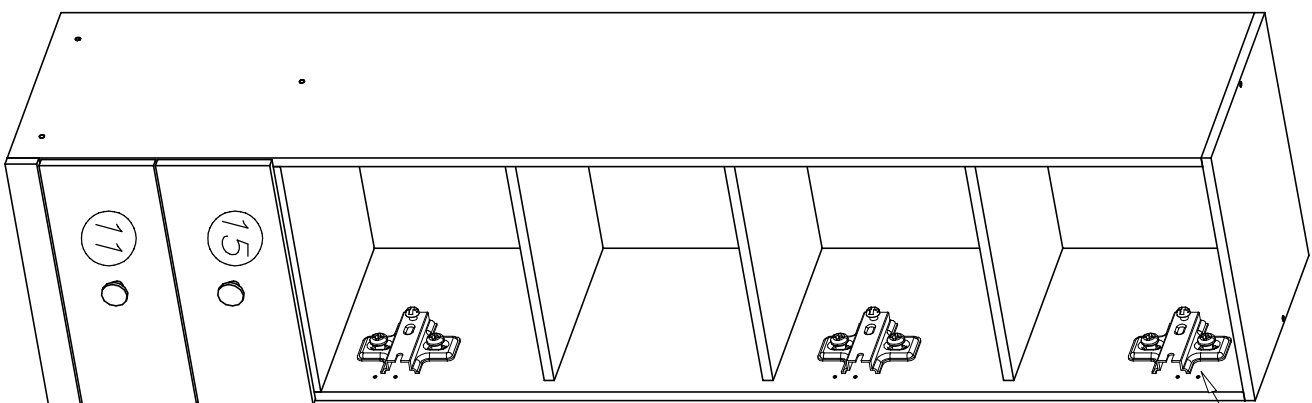
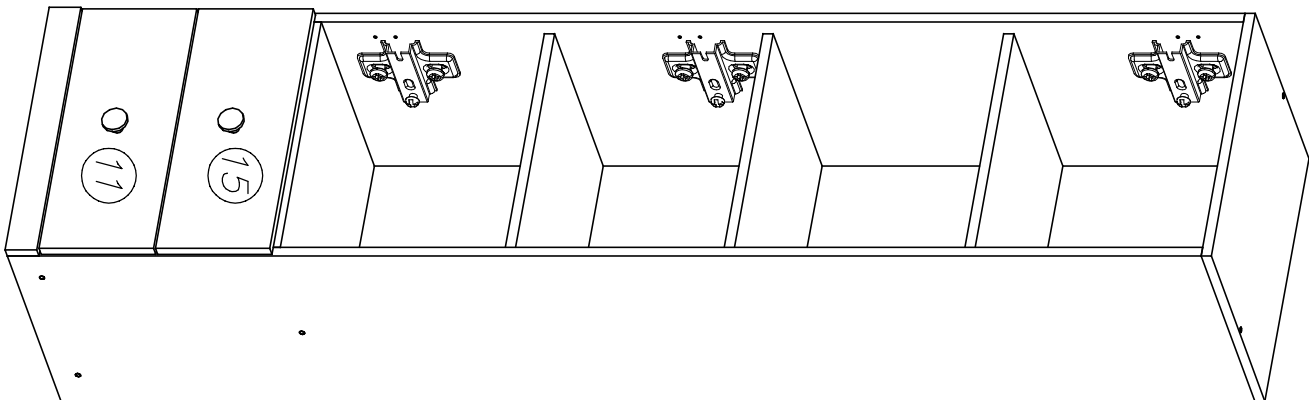
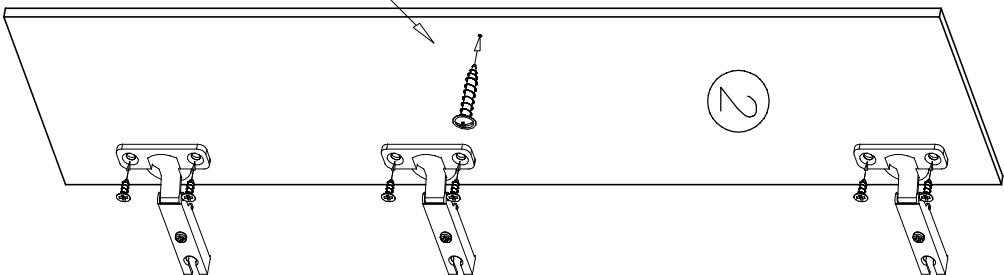
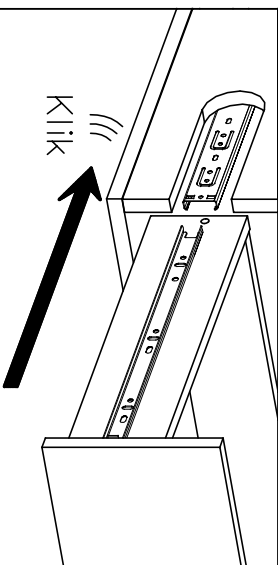

G4

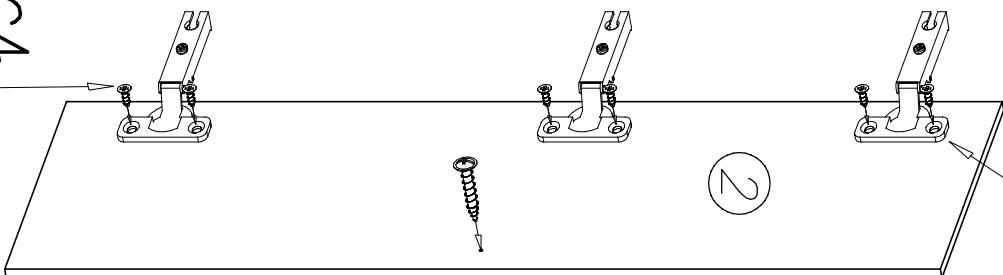

D3

C3



2

11

15

11

15

2