

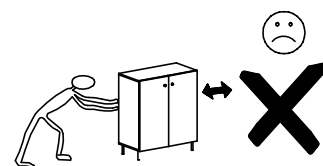

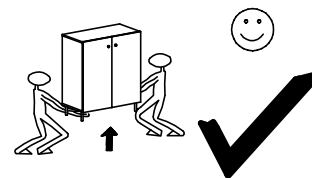

# SERGIO SE 5

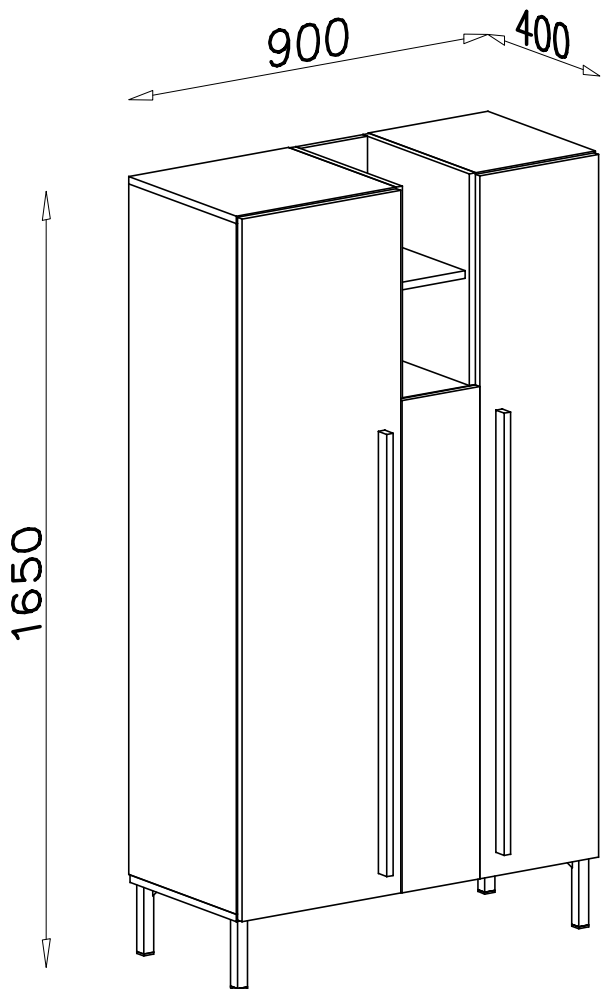
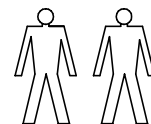
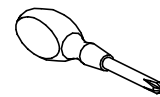
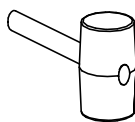
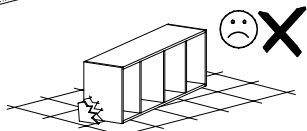
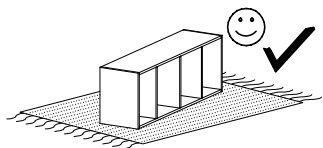

**B2**  
  
 ø6x30 x12

**G8**  
  
 4x30 x8

**E2**  
  
 940mm x2

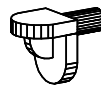
**F1**  
  
 x24

**I7**  
  
 ø18 x10

**W1**  
  
 GLUE, LEIM, LEPIDLO, LIM x2

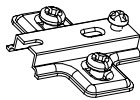
**D3**  
  
 PZ35 x6

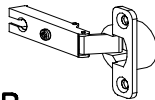
**C3**  
  
 Z35PR x6

**S2**  
  
 x13

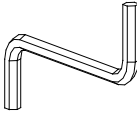
**W2**  
  
 x1

**G4**  
  
 4x16 x12

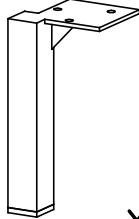
**P7**  
  
 x4

**G10**  
  
 6x13 x12

**G2**  
  
 3x20 x50

**A1**  
  
 ø7x50 x10

**B7**  
  
 ø8x30 x31

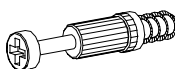
**K5**  
  
 x10

**K1**  
  
 ø15x12 x10

1

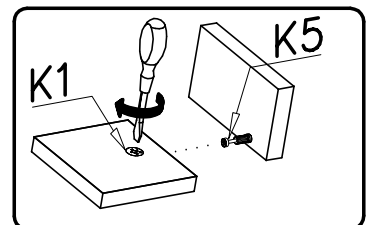
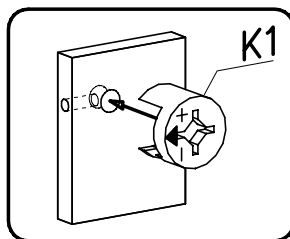
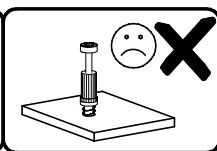
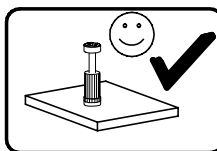
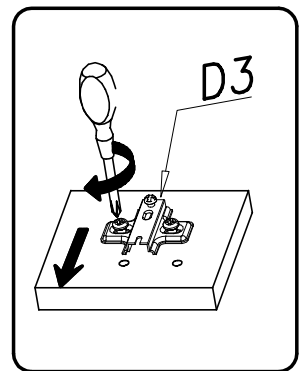
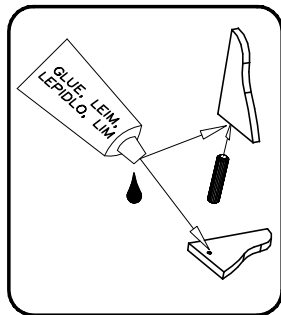
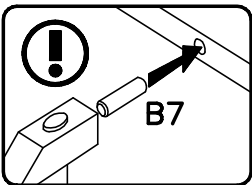
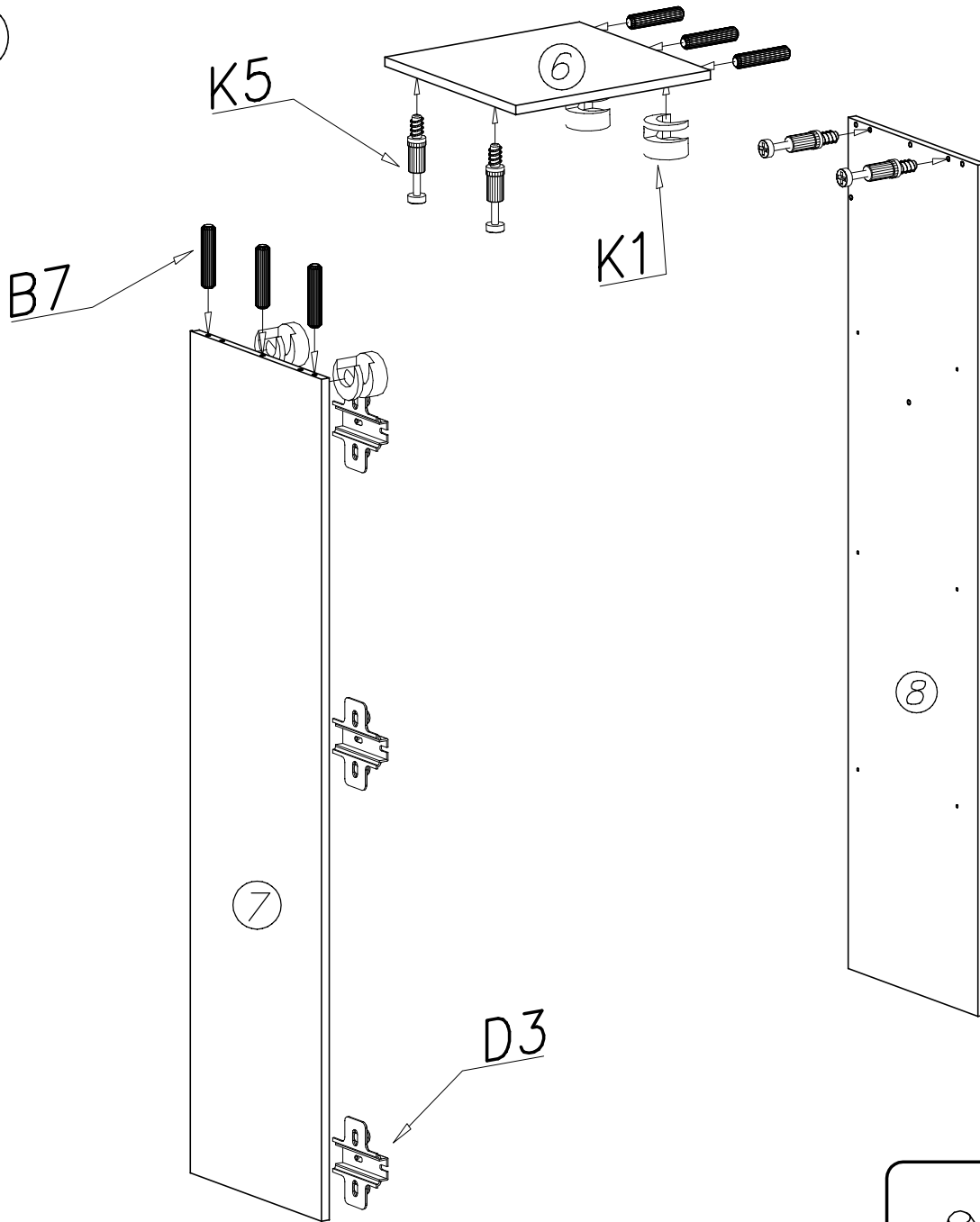

II

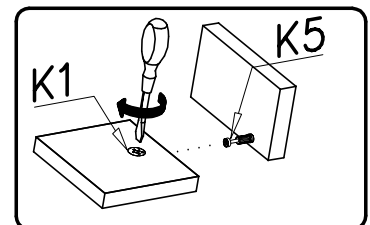
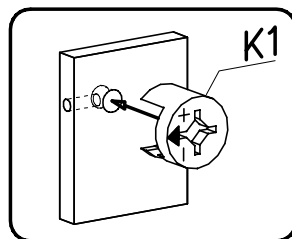
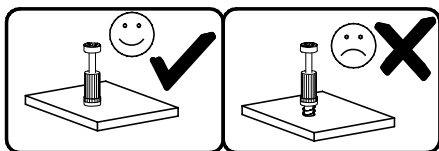
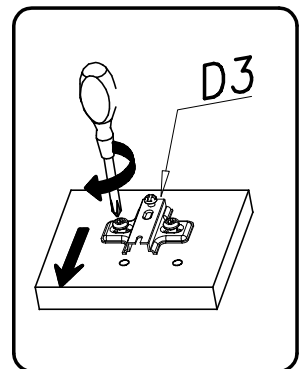
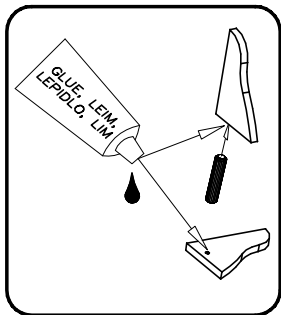
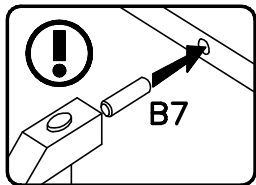
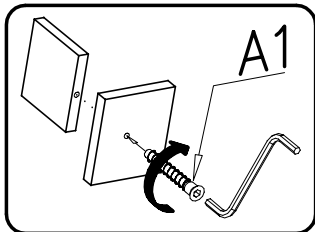
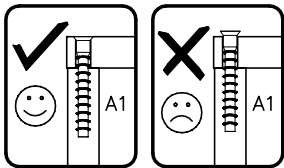
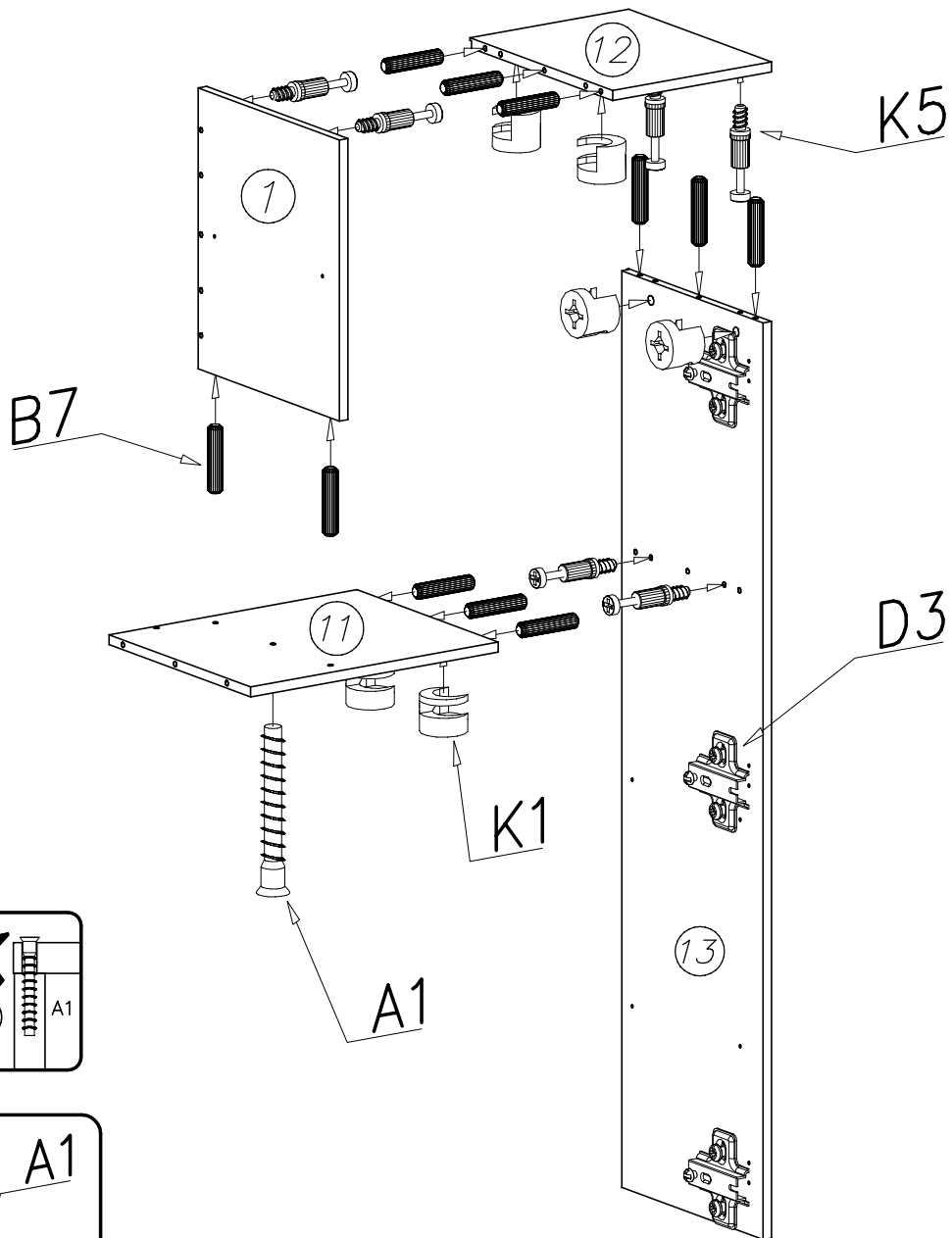

III

B7

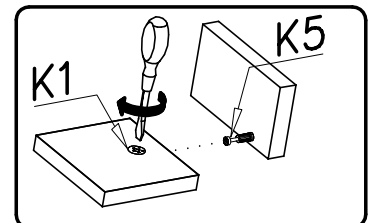
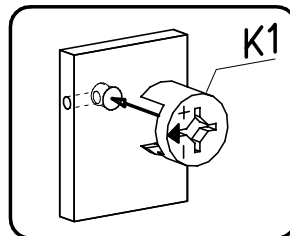
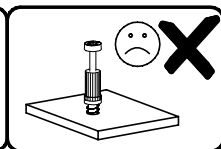
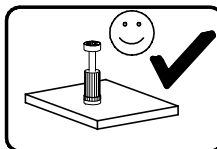
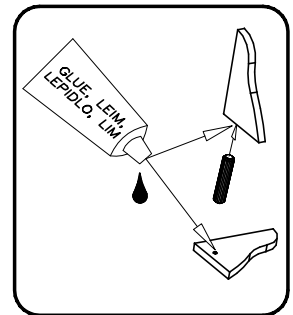
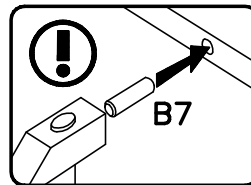
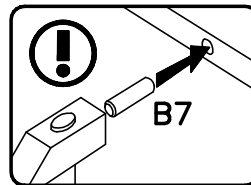
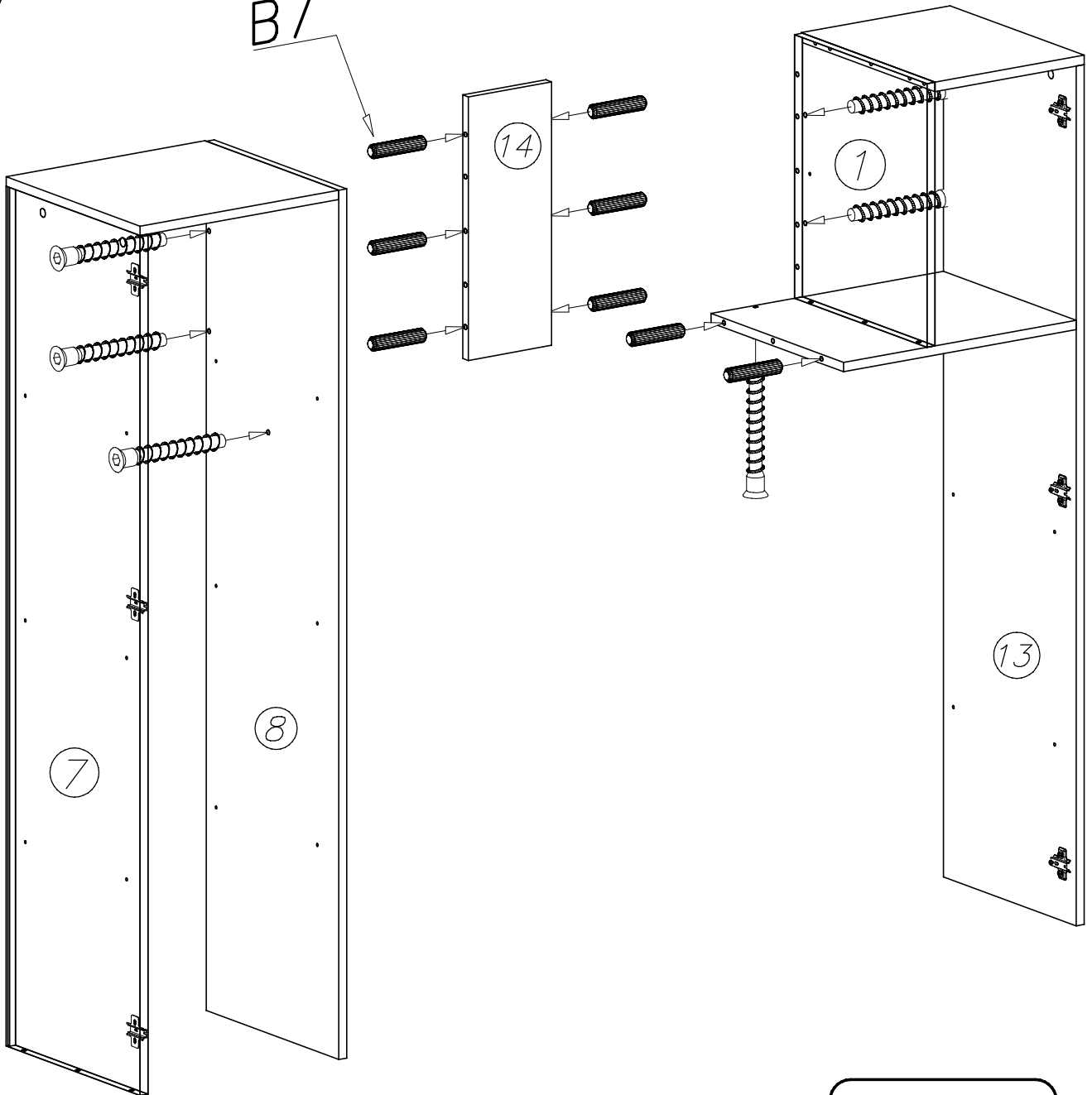

IV

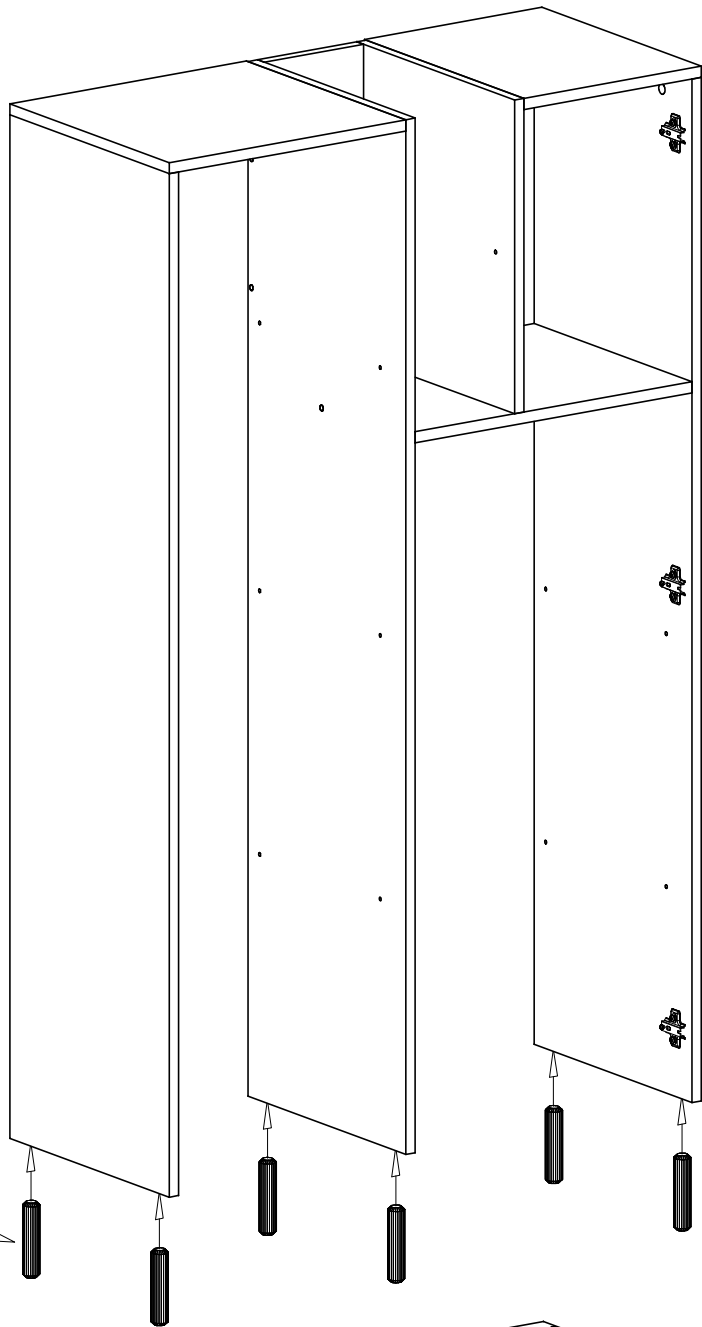

B7

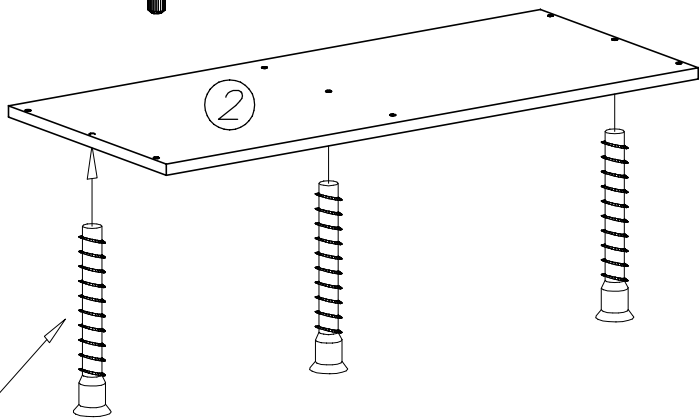

A1

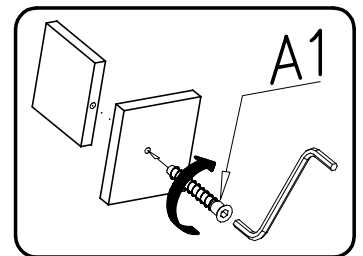
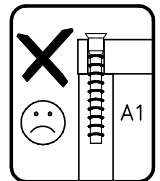
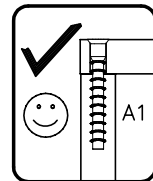
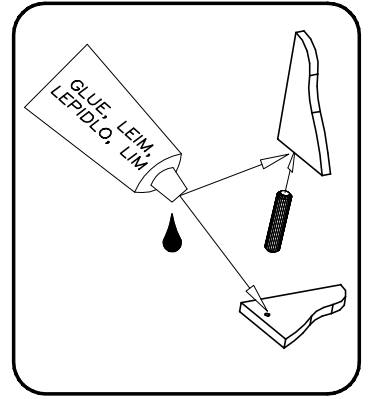
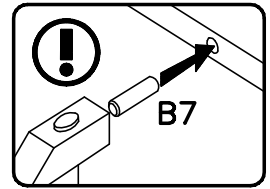

V

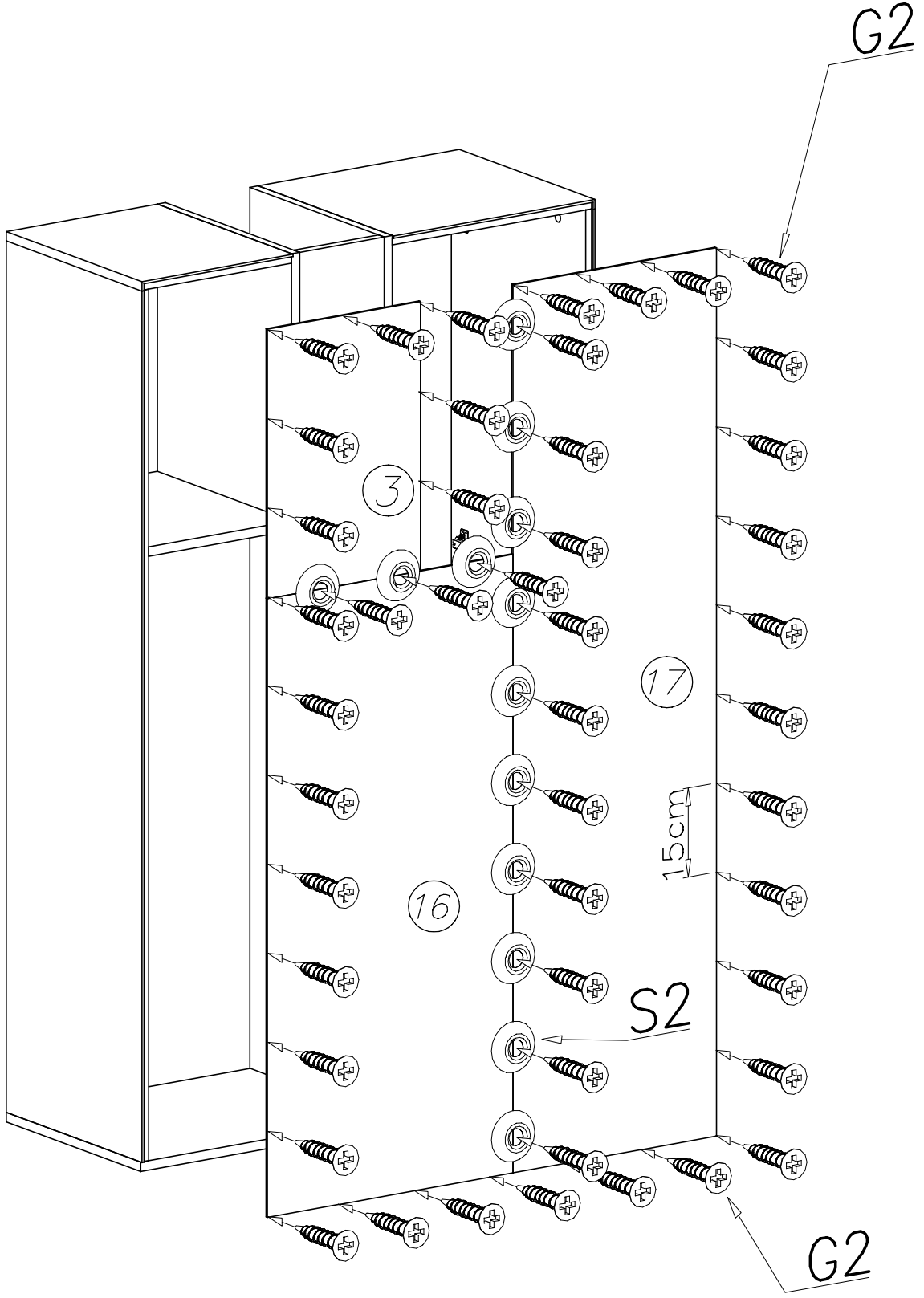
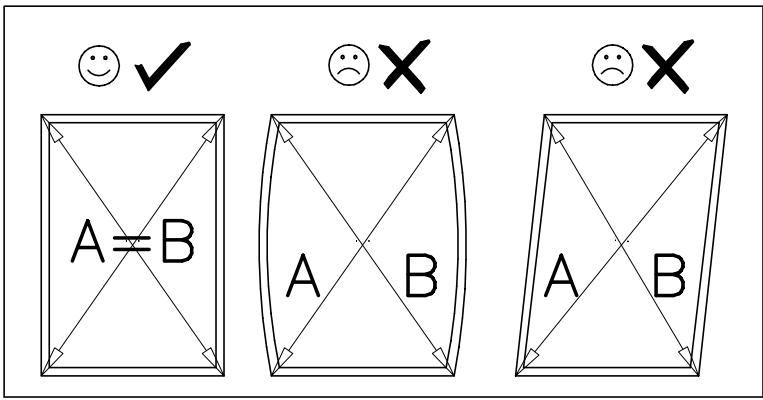

VI

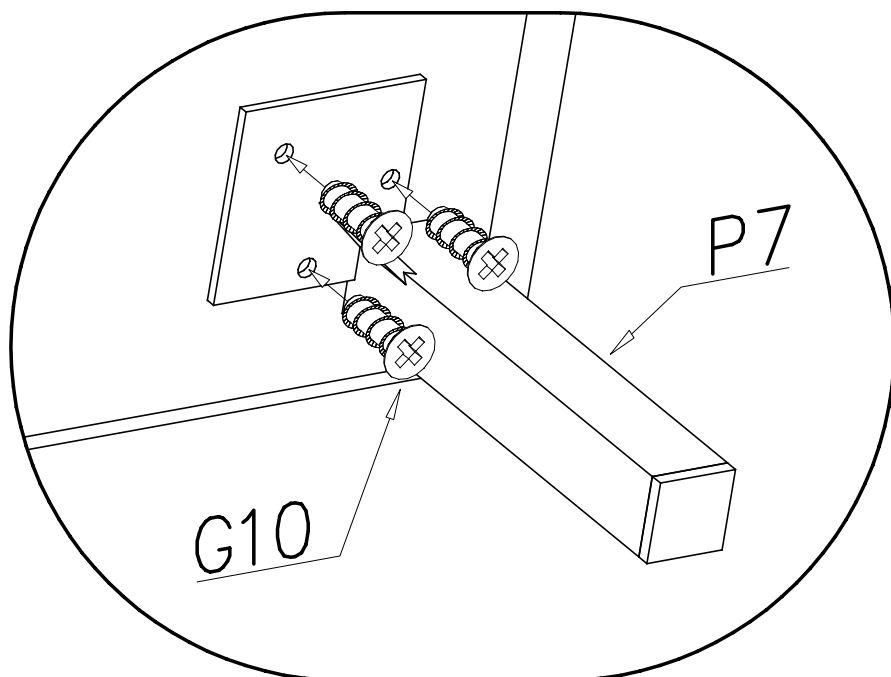
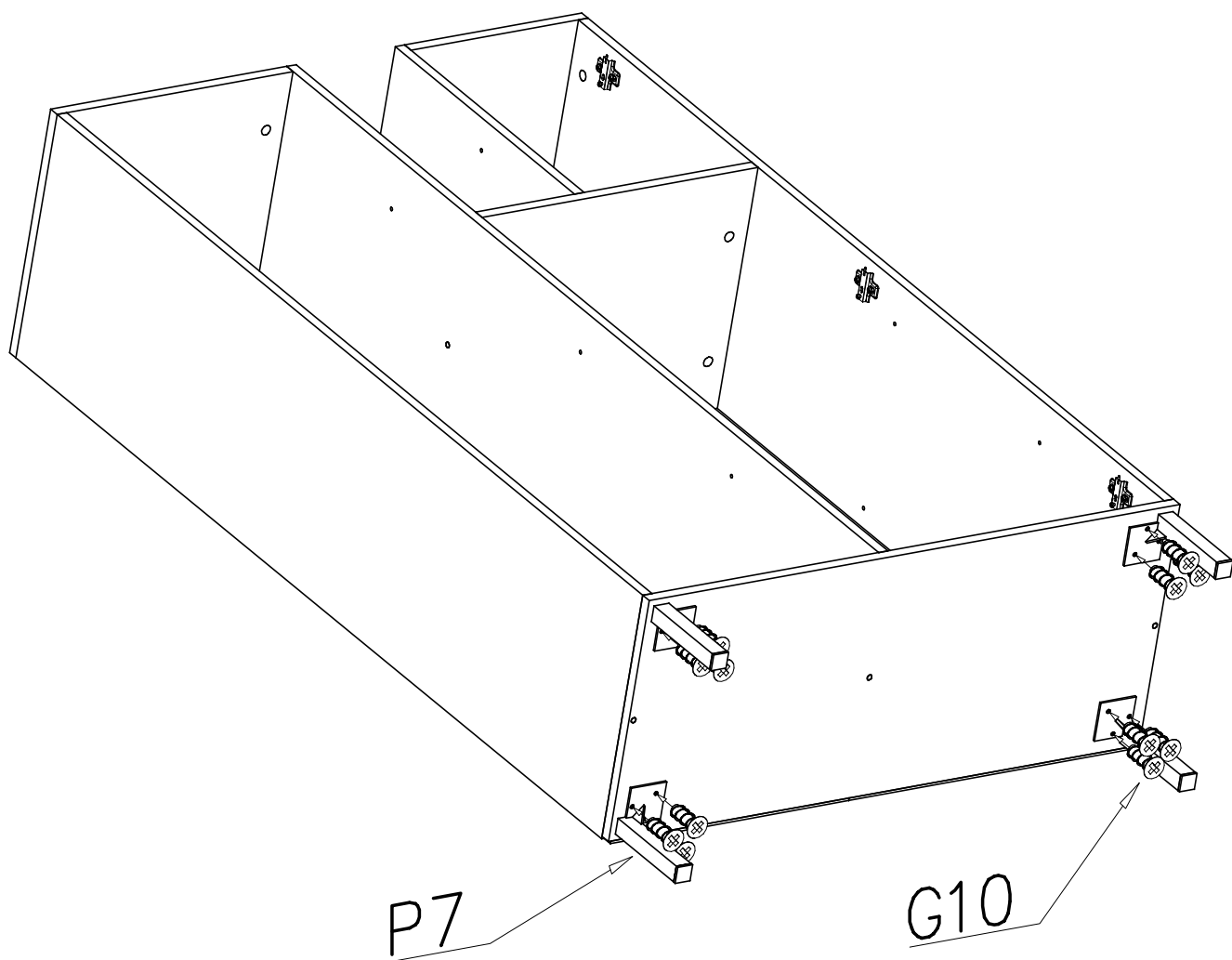

VII

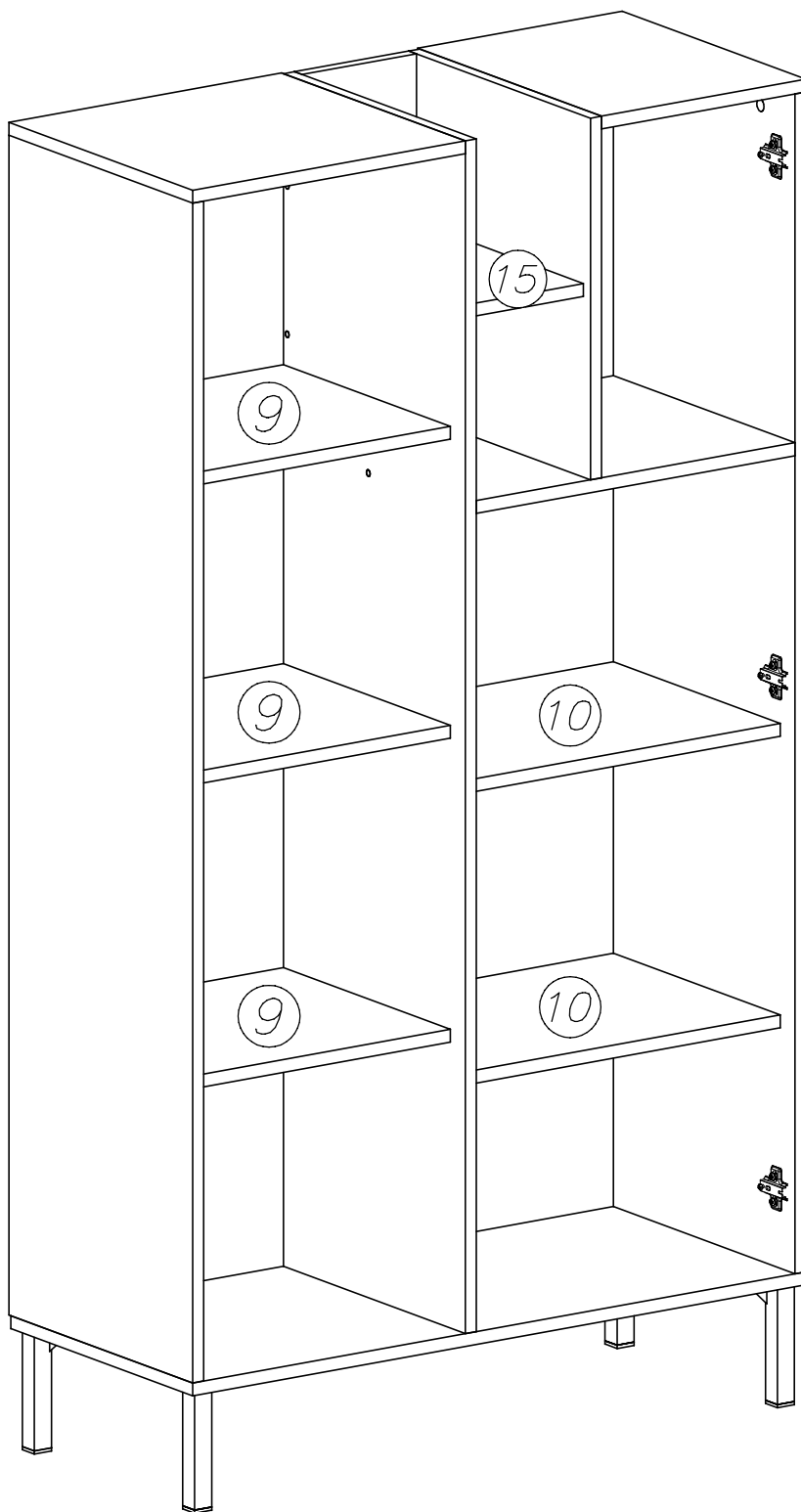

1

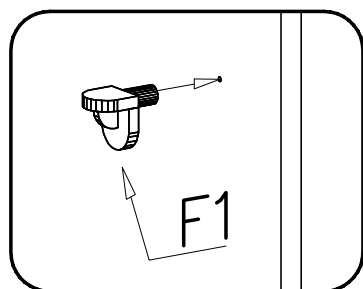

2

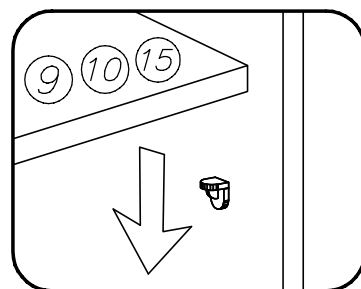



VIII

