

TABLO TA 2

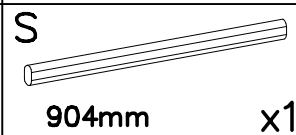

I

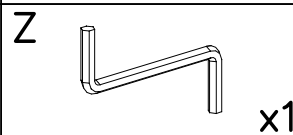
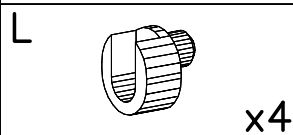
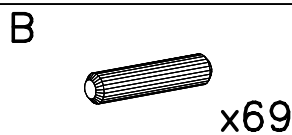
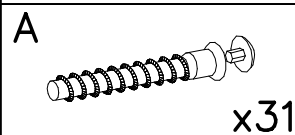
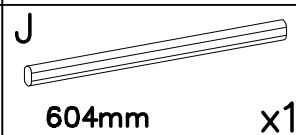
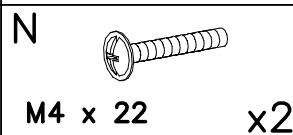
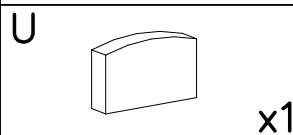
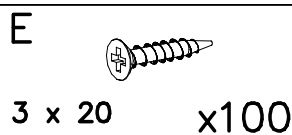
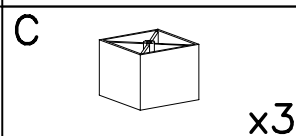
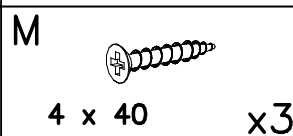
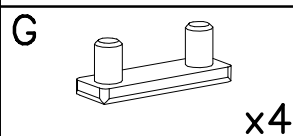
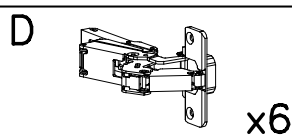
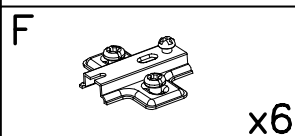
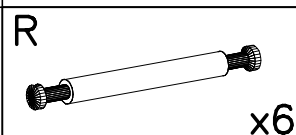
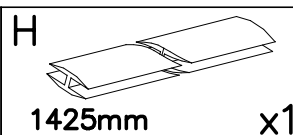
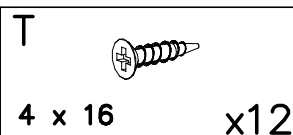
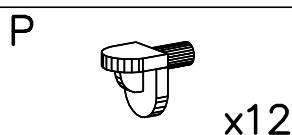
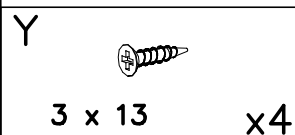
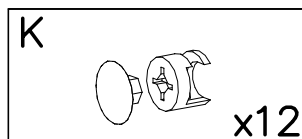
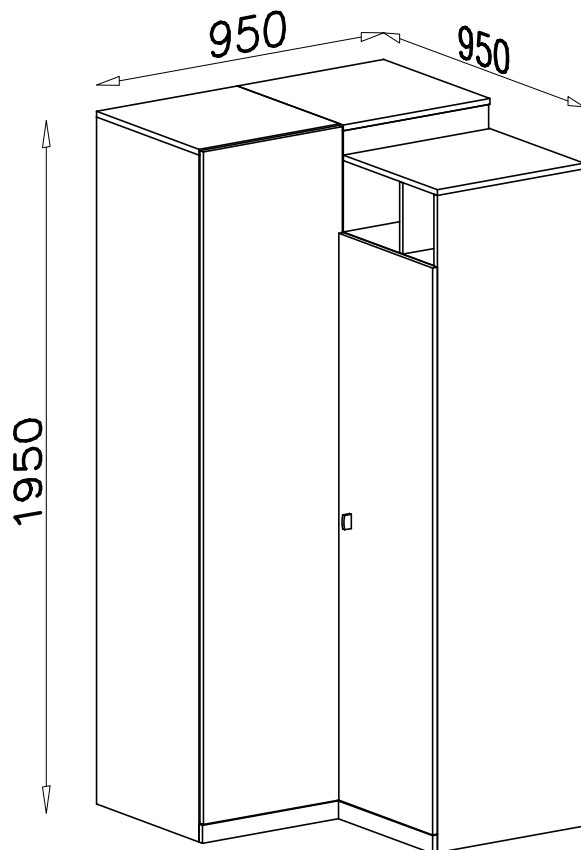
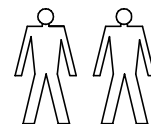
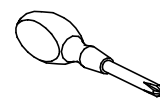
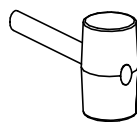
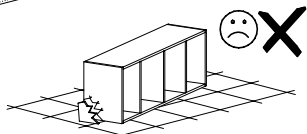
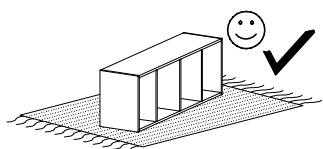
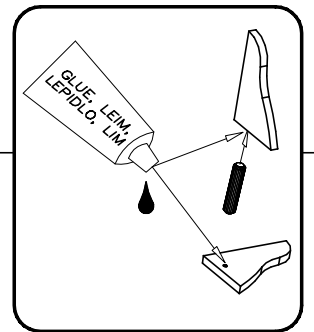
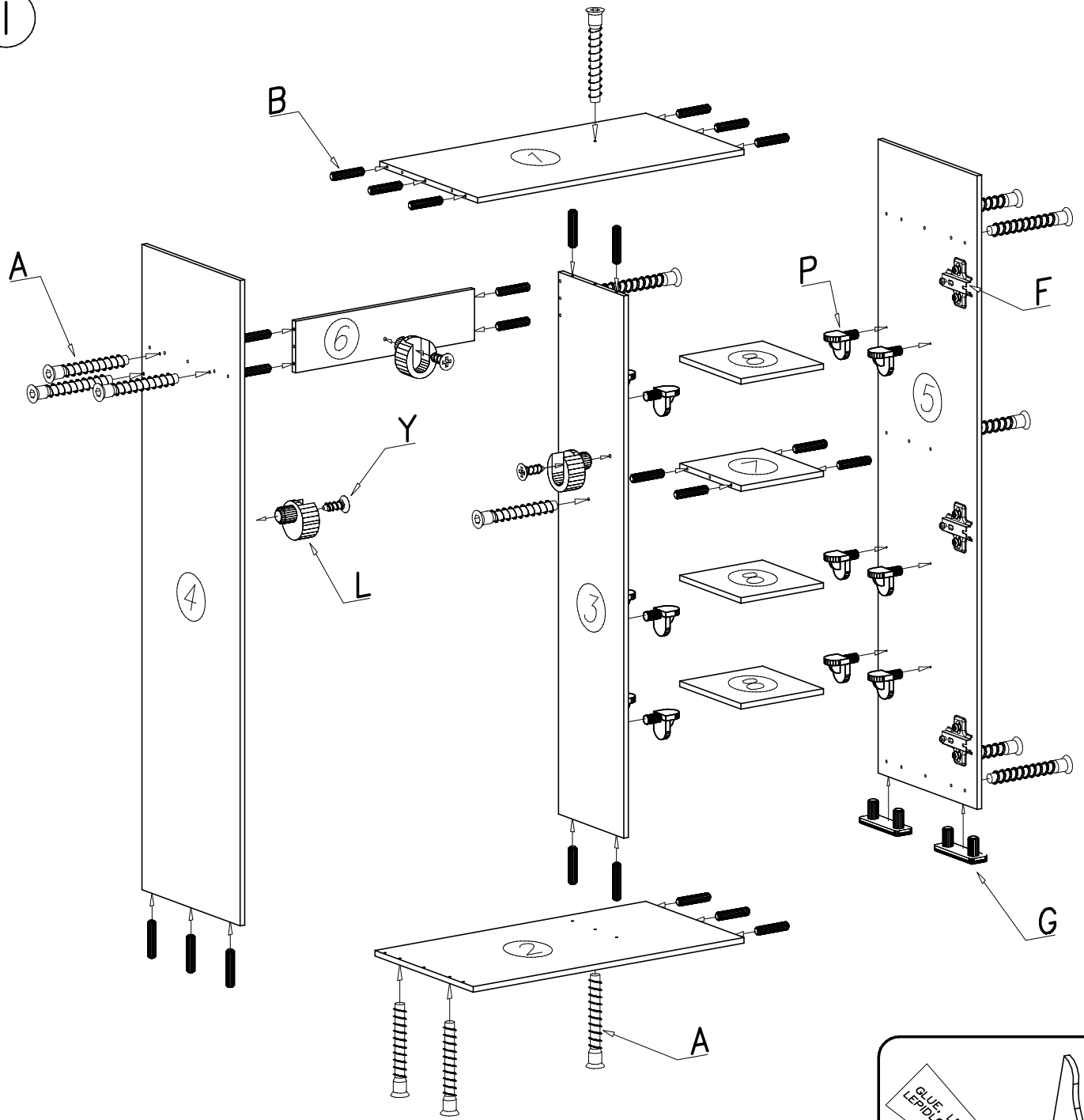

II

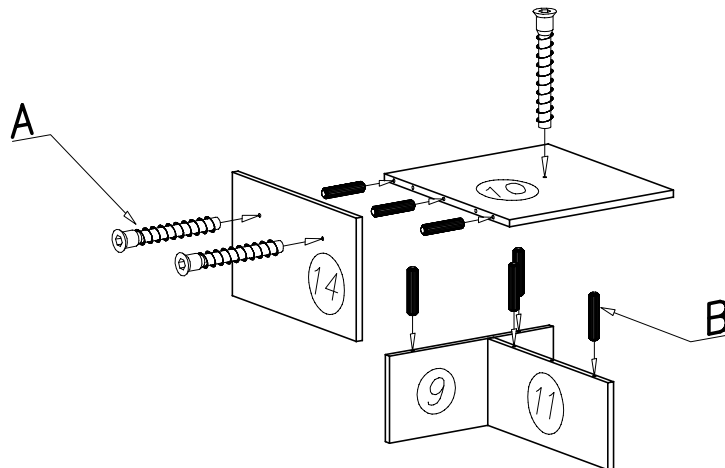

V

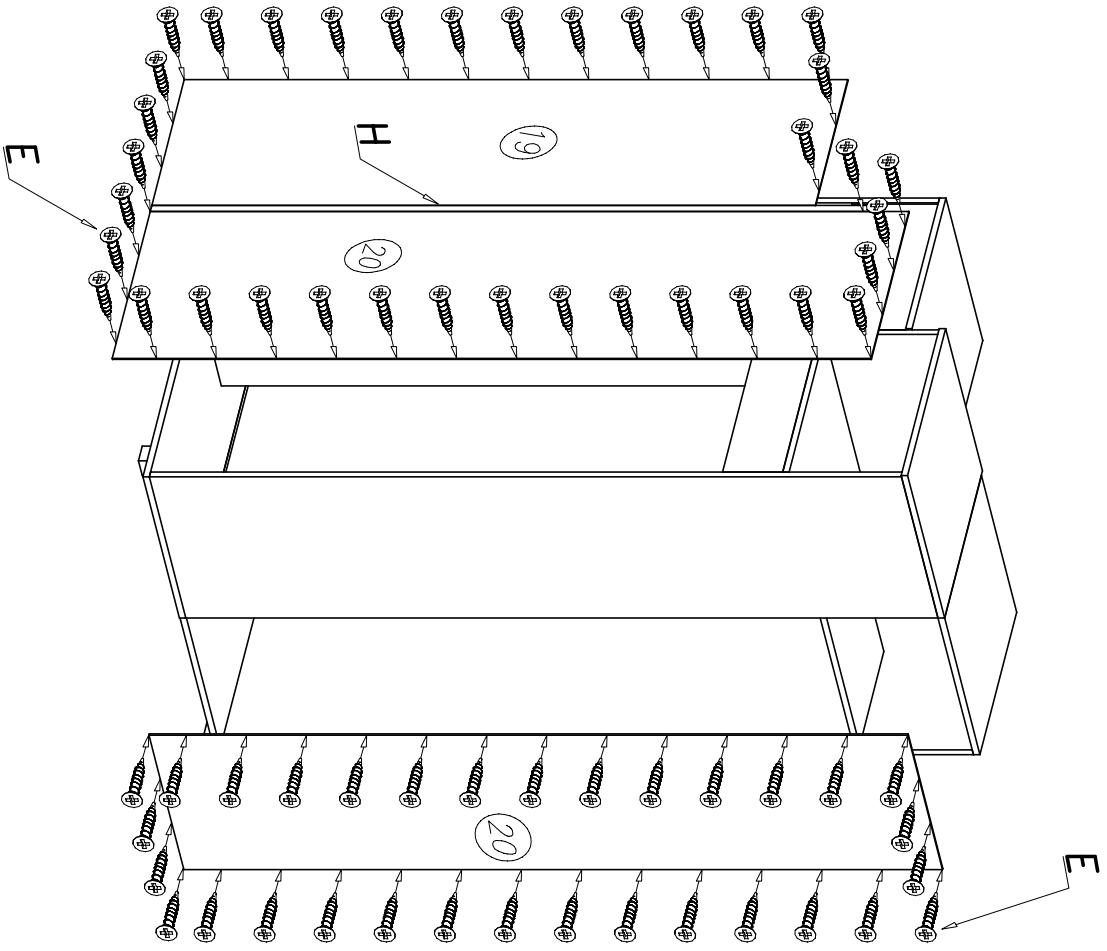

VI

